

## **Original instructions** *Instruction manual*

### **Important!**

Read this instruction manual carefully before first operation and strictly observe the safety regulations!

## **Battery backpack sprayer**

en



## Original instructions

Read this instruction manual carefully before first operation and strictly observe the safety regulations!

Changes to the scope of supply in form, technology and equipment are reserved. No claims can be derived from any information and figures in these original instructions.

The original packaging and, at the end of its service life, the sprayer must be properly disposed of according to the local environmental regulations.

Information about material ingredients

(VO (EC) No.1907/2006 „REACH“)

can be found on our homepage under:

<https://de.solo.global/de/content/12-service>

## 1 Wear parts

The following wear parts are not subject to the manufacturer's guarantee:

- \* All rubber parts that come into contact with spraying liquid, \* nozzles, \* filters, \* seals, \* rechargeable battery

## 2 Warranty

Please observe that specific warranty conditions are valid in some countries. In doubt, ask your vendor.

No guarantee can be granted for any damage caused by:

- Non-observation of the original instructions.
- Omission of necessary maintenance and cleaning work.
- Wear and tear from regular use
- Use of unapproved working tools.
- Use of force, improper treatment, abuse or accident.
- Improper use.
- Connection to an unsuitable power grid.
- Manipulations by non-qualified persons or from improper repair attempts.
- Unauthorized modifications to the device.
- Use of unsuitable spare parts or non-genuine spare parts.
- Use of unapproved chemicals or dilutions.
- Damage caused by use in the rental business.

Any warranty work must be performed by one of our authorised specialist vendors. Cleaning, care and standard adjustments are not accepted as warranty services.

For Australia only: Supplementary warranty notes specifically for Australia

To make a claim, contact Clayton Engineering, 26 French Ave, Brendale, Q, 4500 on phone 1300 798 022 or email [sales@claytonengineering.com.au](mailto:sales@claytonengineering.com.au). You will be asked to provide proof of purchase and then will be instructed on the procedure for repairing or replacement of the product under warranty. All costs incurred for repair or replace,

and additional claims can be discussed at this stage.

This warranty is provided in addition to other rights and remedies you have under law: Our goods come with guarantees that cannot be excluded under the Australian Consumer Law. You are entitled to a replacement or refund for a major failure and for compensation for any other reasonably foreseeable loss or damage. You are also entitled to have the goods repaired or replaced if the goods fail to be of acceptable quality and the failure does not amount to a major failure.

## 3 EC declarations of conformity

Product: Battery backpack sprayer

SOLO Kleinmotoren GmbH, Industriestraße 9, D-71069 Sindelfingen, GERMANY

declares that the following machine, in the delivered version, corresponds to the provisions implementing the following directive: 2006/42/EG, 2009/127/EG, 2014/30/EU, 2011/65/EU.

Product designation: Battery backpack sprayer,  
Trade designation: SOLO 442,  
Serial/type designation 44202,

Storage location for the technical documents and documentation officer:

SOLO Kleinmotoren GmbH,  
Industriestraße 9,  
D-71069 Sindelfingen,  
GERMANY

May 1<sup>st</sup>, 2021

Andreas Emmerich (managing director and documentation officer)



Product: Lithium-Ion battery charger

Name and address of the manufacturer:

SOLO Kleinmotoren GmbH

Industriestraße 9, 71069 Sindelfingen, GERMANY

This declaration of conformity is issued under the sole responsibility of the manufacturer.

Object of the declaration:

Battery charger SOLO 14922

The object of the declaration described above is in conformity with the relevant Union harmonisation legislation: 2014/35/EU, 2014/30/EU, 2011/65/EU, 2012/19/EU

References to the relevant harmonised standards used or references to the other technical specifications in relation to which conformity is declared:

EN 60335-1:2012/A2:2019

EN 60335-2-29:2004/A11:2018

EN 62233:2008, EN 55014-1:2017

EN 55014-2:2015, EN 61000-3-2:2014

EN 61000-3-3:2013, EN 50581:2012

Andreas Emmerich May 1<sup>st</sup>, 2021  
(managing director and documentation officer)



## 4 Scope of delivery

- Basic unit with hand valve and pressure hose
- Spray tube
- Pre-installed nozzle assembly incl. flat spray nozzle
- Alternative spray nozzle: adjustable hollow cone nozzle
- Assembly parts cap but, O-ring
- Carrying belt and attachment pin
- Rechargeable battery
- Charger

## 5 Symbols



Read the original instructions thoroughly.



DANGER! Non-observation of the original operating manual may cause accidents with injuries.



Wear the prescribed protective clothing.



Wear protective gloves.



Wear facial protection (e.g. goggles).



Wear breathing protection.



No smoking.



No open fire.



Minimum distance from other persons: 15 m [approx. 16 yards]

Electrical equipment must not be disposed of as normal domestic waste.



Ensure that the device, the rechargeable battery and the battery charger are disposed of or recycled at an official disposal or recycling facility for electrical equipment.



Battery charger: For indoor use only



Battery charger: Class II Construction

## 6 Safety provisions

### 6.1 Intended use / applications

#### Battery backpack sprayer

- Use the device only for application of liquid herbicides, pesticides and weed killers as well as liquid fertilisers that are available in authorised specialist trade and approved by local/national authorities for use with portable spraying devices and for application of clean water.

- Strictly observe the information on the spraying agent, in particular instructions on personal protective equipment.
- Application areas are in farming, tree nurseries, forest operations, orchards, vineyards, market gardens, as well as glasshouse cultures with sufficient ventilation and venting.
- The device must not be used for any other purposes, such as application of other agents from the above liquids! In particular, no acids, alkalis, solvent-containing liquids and waterproofing agents must be applied.
- Never use any liquids with temperatures above 40 °C [104 °F].
- Do not use any flammable agents.

#### Battery charger

- The charger should only be used for charging the original SOLO 18 V battery indoors. The charger must not be used for any other purpose, such as charging other batteries! The appliance is not to be used by persons (including children) with reduced physical, sensory or mental capabilities, or lack of experience and knowledge, unless they have been given supervision or instruction. Children are to be instructed not to play with the device.



Never connect non-rechargeable batteries to the charger!

- The mains must correspond to the information on the charger in value, type, and frequency of the operating voltage.

#### Battery pack

- The battery is only to be used to operate a SOLO 18 V cordless tool. The original instructions of the cordless device must be completely taken into account. The battery must not be used for any other purpose, such as for operating other devices!

### 6.2 General safety notes

Read the original instructions before first use and keep it in a safe place.

Non-observation of information provided in these original instructions may potentially be fatal; the user is liable for any damage, direct or consequential, caused by this.

The original instructions must be kept on hand at the site of use of the sprayer at all times.

It must be read by all who are charged with any work with and on the device (including for maintenance, care and repair).

- Have safe use shown and explained to you by a SOLO specialist vendor.
- Persons under the age of 18 must only work under supervision with this sprayer.
- Persons with medical implants must consult a doctor before using the device or request information from the implant's manufacturer.

- Keep persons and animals away from the working area. Never spray in the direction of any persons, animals or objects that could be hurt or damaged.
- This sprayer must only be passed on to persons who are familiar with this model, its operation and the original instructions.
- If you work with this sprayer, you should be physically fit, rested and healthy.
- Do not use the sprayer while under the influence of alcohol, drugs or medication.
- Never make any changes to existing safety provisions and operating parts.
- Only use the sprayer when it is operationally safe to do so. Check the sprayer before every use according to chap. 10.1.
- Replace damaged parts without delay. Only use SOLO genuine spare parts.
- Only use the genuine battery. Accessories and batteries must be approved for this device.
- Empty and clean the sprayer according to the information in chap. 10.4 for this. Prevent unauthorised access to the machine.

In case of serious disturbances such as smoke development or strong odours remove the unit from your body. If there aren't flames yet and the battery is not too hot, remove the battery from the device and place it on a fireproof surface. Keep a sufficient safety distance. In the event of a fire, call the fire brigade immediately. Have the equipment checked immediately by an authorized specialist workshop.

### 6.3 Safe handling of spraying liquids

- Follow suitable procedures and use collection containers to prevent any contamination of the environment, the public waterways and/or storm water systems from chemical agents and cleaners. This can happen while mixing, filling, using, emptying, cleaning or during transport.
- Always collect chemical spray liquids and cleaners (including residues) in suitable containers and return them to collection points specified by the municipal administration.
- In case of skin or eye contact, rinse or flush the affected body parts with plenty of clean water. Seek medical advice without delay.
- Contaminated clothing should be changed at once.
- Never eat or drink while handling spray liquids
- If you feel nauseous during work, or if you are excessively fatigued, stop working at once. If the condition persists, seek medical advice without delay.
- Never permit children or persons work with or handle spraying liquids if they are not familiar with these substances.
- Never fill different spray solutions into the spray tank.

- The description of the kind of spray solution used must be attached to the device and must be updated with every change of the spraying solution.
- When changing the spray solution, clean the spray tank and all parts that come in contact with the spray solution. Operate the sprayer with clear water first before filling the spray tank with the different spray solution.
- At the end of work, empty and clean the sprayer according to chap. 10.3, clean your face and hands thoroughly, take off work clothing and wash it regularly.

### 6.4 Safe handling of the battery and charger



- Leave the battery in the original packaging until you want to use it.
- Keep the battery away from open flames and do not expose it to direct sunlight or other heat.
- Keep the battery clean, dry and away from splash water. Remove dirt only with a dry cloth.
- Never immerse the battery in a liquid.
- Never short-circuit the contacts with a conductive object. Do not store the rechargeable battery together with conductive objects and other rechargeable batteries or batteries in a box or drawer so that a short circuit cannot occur.
- The battery must not be opened, disassembled or shredded.
- Do not subject the battery to mechanical shock.
- If a liquid escapes, it must not come into contact with the skin or get into the eyes. In case of contact, wash the affected area with plenty of water and get medical attention.
- The use of the battery by minors must be supervised.
- The battery may only be charged in an operationally safe condition and installed in a device. The housing must not be damaged. If you are unsure, have the battery checked by an authorized specialist workshop.
- Charge the battery before installing it in the device. Only an original SOLO charger with the appropriate nominal output voltage should be used to charge the battery. The original instructions for the charger must be fully observed.
- Do not charge the battery for a long time when it is not in use.
- Use only the original battery provided in the intended SOLO device. Do not install different batteries. In the event of a replacement, only purchase the original battery.
- Remove the battery from the device and store it safely when the device is not in use.
- After a long storage period, the battery may only reach its full performance again after repeated charging and discharging.



- When the battery has reached the end of its service life, dispose of it properly at the official collection points.
- Do not charge during long-term absences (holidays).
- After charging, immediately disconnect the charger from the power supply and only connect it again for the next use.
- Always hold the body of the plug when plugging it in and disconnecting it. Never pull it out by the cable.
- Never immerse the charger in a liquid.
- Keep the charger away from splash water.
- The charger may only be connected to the power supply when it is in a safe operating condition. The plug, the cable and the device housing must not be damaged. If you are unsure, have the equipment checked by an authorized specialist workshop.
- If smoke occurs or melting of the housing or cable is detected, disconnect the charger from the mains immediately and do not use the battery or the charger. Have the battery and charger checked by an authorized specialist workshop.
- Do not operate power tools in potentially explosive atmospheres, eg. b. in the presence of flammable liquids, gases or dust.
- Place the charger on a firm surface during operation so that air can also circulate between the surface and the charger.

### 6.5 Work clothing /personal protection equipment (PPE)

 Suitable and approved protective clothing that protects all body parts from contact with the spray solution must be worn.

- Wear firm shoes with good gripping soles.
-  Wear protective gloves with a slip-proof palm.
-  Use facial protection (e.g. protective goggles).
-  Always wear a breathing mask. when working in dense, tall plants, greenhouses, troughs or trenches and when using dangerous spraying agents.

### 6.6 Before and during work

- Before starting work, always check the entire device for operational safety according to chap. 10.1.
- The sprayer must only be operated by one person. There must be no other person within a radius of 15m [approx. 16 yards].
- Always ensure sufficient air exchange in dense plant growth, in greenhouses, troughs or trenches.

- Always stay within calling distance from other persons that may provide help in emergency.
- Take regular working breaks to prevent fatigue.
- Do not smoke at the workplace.
- In case of serious disturbances or accidents during operation of the device as smoke, strong odors from the device or if the device is in flames instantly remove the unit from your body and take a safe distance. In case of fire, you have to call the fire department immediately.
- When switching on the pump, ensure that the shut-off valve is closed. Point the spray tube towards a free area.

### 6.7 When transporting the sprayer

- Always switch off the pump when transporting the device.
- Depressurise the device in accordance with chap. 9.2.
- The device must be securely strapped down when transported on vehicles.
- Prevent leakages of spraying agents. The liquid tank of the sprayer and all liquid carrying hoses must be inspected regularly for leaks.
- The lithium-ion battery is subject to the requirements of dangerous goods law. The battery can be transported on the road by private users without any additional requirements. Only transport the battery if it is undamaged. The battery must be secured against contact with other objects, short circuit and unintentional slipping. When shipping by third parties, special packaging and labeling requirements may have to be observed.

### 6.8 Maintenance, repair and storage

Only perform maintenance and repair work yourself that is described in these original instructions. All other work must be carried out by an authorised specialist workshop.

- Do not service, repair or store the sprayer near open fire.
- Always turn off the pump before any maintenance and repair work.
- The pressure hose, hand valve, spray wand and nozzle assembly must only be unscrewed when the sprayer is depressurised. For this, keep the spray tube in the spraying agent tank or a suitable collection container with the pump turned off for the spraying agent until liquid is no longer being transported.
- Never open the battery pack and the charger. Maintenance and repair work may only be carried out by an authorized specialist workshop.
- Only a dry or only slightly damp cloth should be used for cleaning. The charger must be disconnected from the mains.

## 7 Work preparation

Fig. 1



Fig. 1a

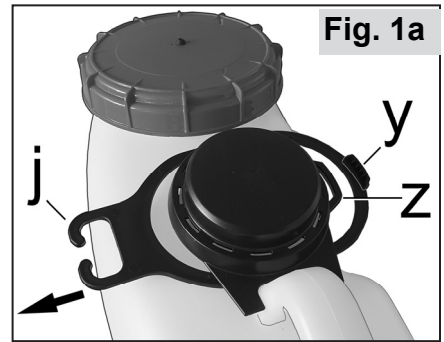

Fig. 1b



- a. Spray tank)
- b. Tank lid screwed to the filling socket (c)
- d. Carry handle
- e. Standing foot
- f. Control panel with on/off switch
- g. Hand valve
- h. Spray wand
- i. Nozzle attachment
- j. Spray tube holder
- k. Carrying belt
- l. Rechargeable battery

Fig. 1a: Pull the spray tube holder (j) forward into the correct position until the groove (y) engages in the tab (z).

Fig. 1b: Outside of work, the spraying wand (h) is attached to the spray tube holder (j).

Only carry the device by the handle (d).

**Fault:** Never carry the device by the spray tube holder (j) or by the black cap.

## 7.1 Assembly

### Assembly of the spraying wand (h):

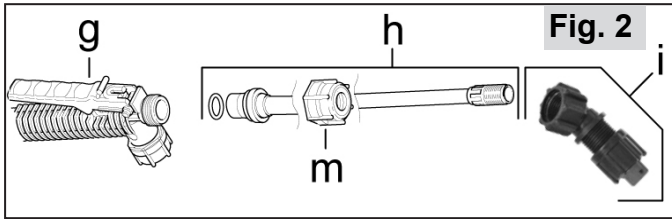

- Start the cap nut (m) evenly and screw the spray tube with the O-ring (16x3 mm) onto the hand valve (g) hand-tight without tools.
- Screw the nozzle attachment (i) onto the spray tube hand-tight without tools.

### Alternative spray nozzle

As an alternative nozzle, an adjustable hollow cone nozzle is included in the scope of delivery.

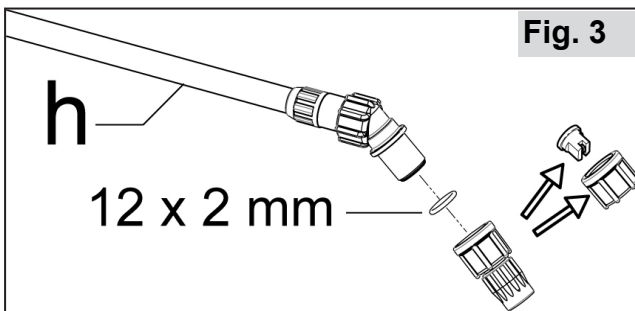

If necessary, replace the adjustable hollow cone nozzle with the pre-assembled standard nozzle (blue flat jet nozzle) as shown in the illustration.

### Adjustment hollow cone nozzle

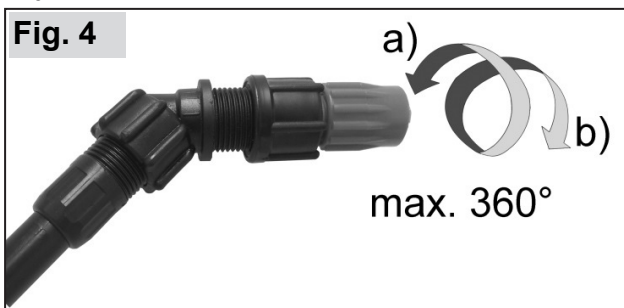

a) Nozzle closed  
→ hollow cone

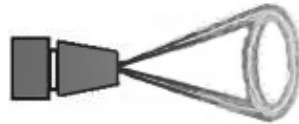

b) Nozzle open  
(1/2 turn 180° until  
max. 1 turn, 360°)  
→ coarse and narrow jet



### Assembly carrying belt

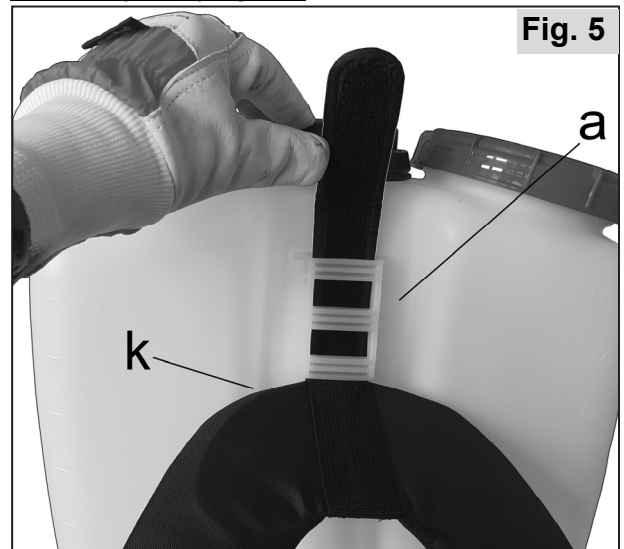

- Thread the Velcro strap of the shoulder strap (k) from below through the three ribs on the spray agent tank (a).

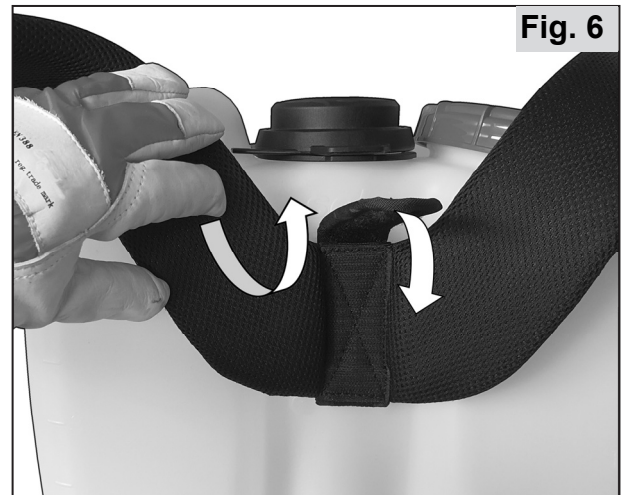

- Fold the shoulder strap upwards as shown and close the Velcro fastener downwards.



## 7.2 Length adjustment of the carrying straps

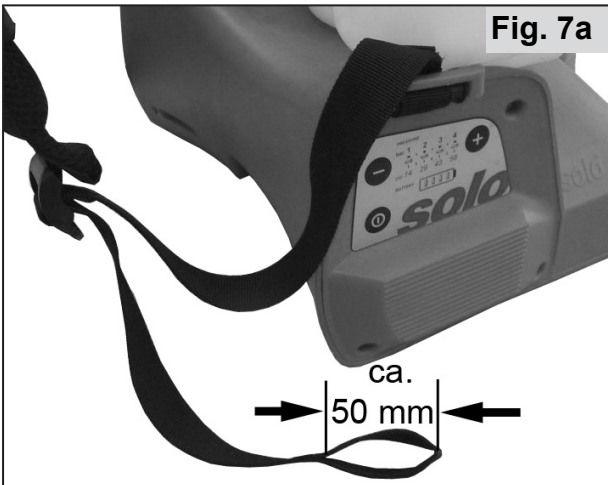
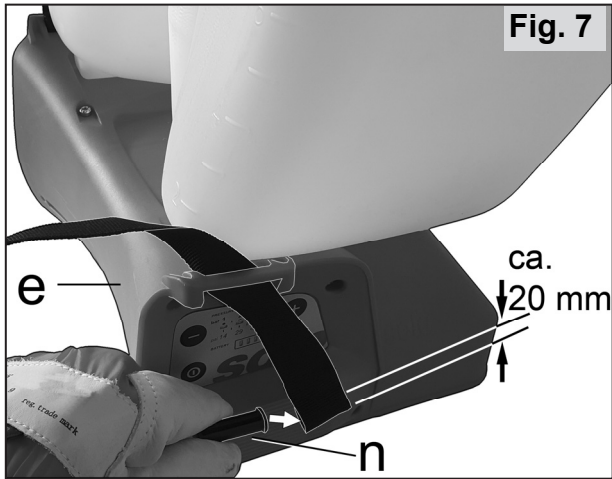

- Thread the ends with the short loop (ca. 20 mm) of each carrying belt through the specified slits in the standing base (e). (**Fault:** If the end with the large loop (approx. 50 mm) is attached to the standing base, the clamping slide (o) is incorrectly aligned and the length adjustment does not hold.)
- Secure the short loop with the attachment pin (n) from below.

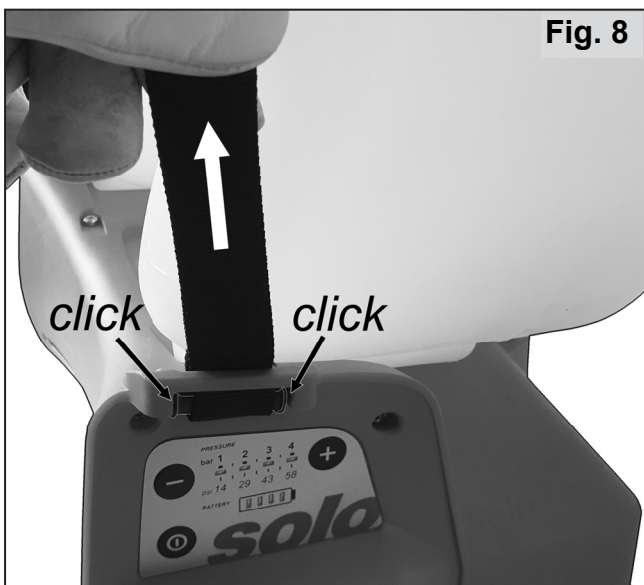

- Pull the belt tightly upwards and thereby snap the fastening pin into place on the base with a click.



Pulling down the two strap ends with the large loop will tighten the carrying straps.



Pulling the two clamping slide (o) upwards will loosen the carrying strap.



Close the chest fastener (p) and adjust the length using the clamping slide.



### 7.3 Filling screen and intake screen

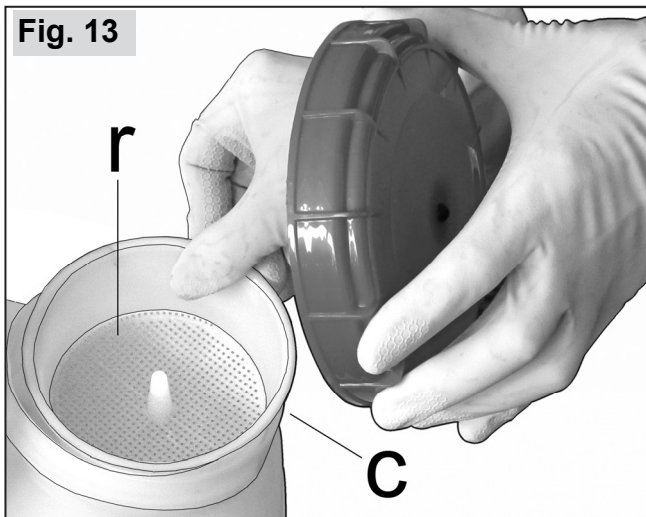

The basket in the filling neck (c) of the liquid tank contains a filter screen (r).

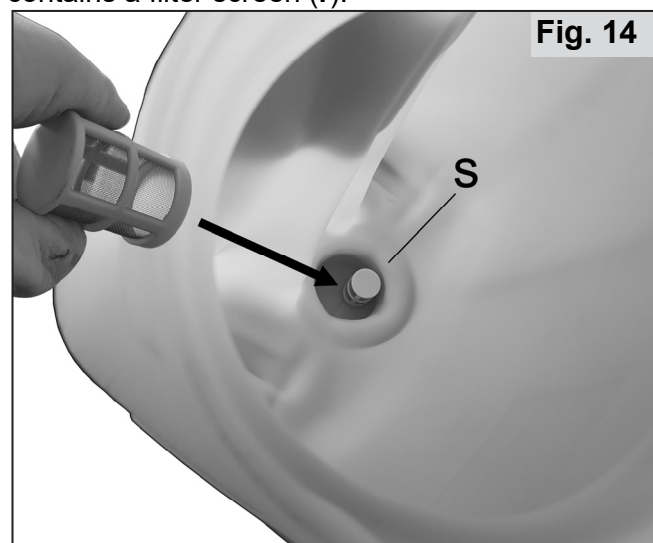

The intake screen (s) is pushed on at the intake hose to the pump of the spraying agent tank.

The filling screen and intake screen are required when using the device.

### 7.4 Charging the battery

Place the charger on a stable surface and connect it to a suitable power supply. All three LEDs light up for two seconds.

Before inserting the battery, make sure that the contacts of the battery and the charger are clean, dry and free of foreign objects.

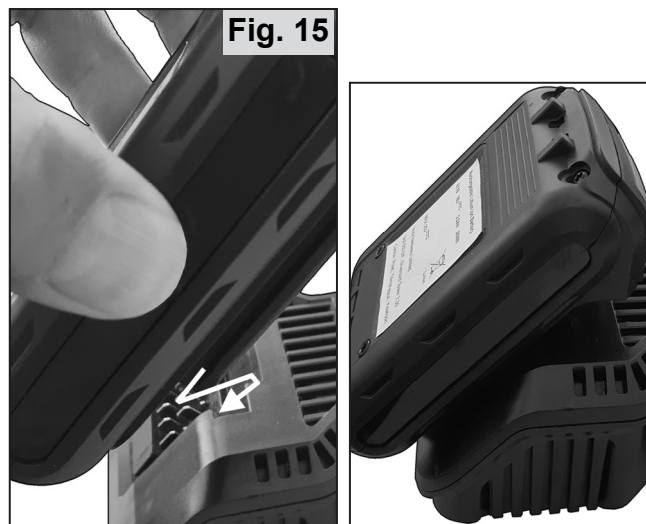

Insert the battery into the charger diagonally from the top using the guide grooves until it clicks into place.

During the charging process, the LED lights show the charging status. - If the charge status is below 30%, all three LEDs flash in succession.

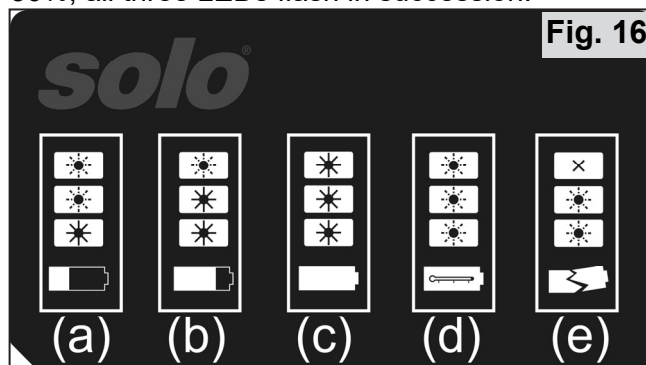

- (a) Charging status between 30% and 60%, one LED lights up continuously while the other two flash in succession.
- (b) Over 60% charged, two LEDs stay on while the third flashes.
- (c) When fully charged, all three LEDs light up permanently.
- (d) All 3 LEDs flash simultaneously → the battery is too hot. Remove the battery from the charger and let it cool down for 15 - 30 minutes. Then put it back in the charger. If the LEDs are still flashing at the same time, the battery and charger must be checked by an authorized specialist workshop.
- (e) Two LEDs flash simultaneously while the third is not lit → the battery is damaged and cannot be charged.

After charging, remove the battery diagonally from the top of the charger. Disconnect the charger from the mains.

## 7.5 Installation of the battery



Insert the battery with the side guide grooves (t) into the receptacle on the SOLO cordless device or charger until it clicks into place with an audible click.

To remove from the SOLO cordless device, hold the release (u) on the battery and pull the battery out.

To remove it from the charger, the release (u) does not have to be held, but the battery can be pulled directly from the charger.

## 7.6 Test run

Before its initial use, the sprayer should be tested according to chapter 10.2.

## 8 Preparing the spray liquid and filling the spray tank

Prepare the spray liquid according to the instructions of the chemical manufacturer.

Always prepare the spray liquid outdoors, never in living quarters, stables or storage rooms for food and animal feed.

When filling the spray tank, always use the filler basket with the integrated filter screen (r).

Fill the tank no further than to the upper-most mark on the side of the spray tank.

Overfilling the tank or spills can contaminate public waterways, rain- and storm water channel and must be avoided.

Wipe off spilled spray liquid without delay.

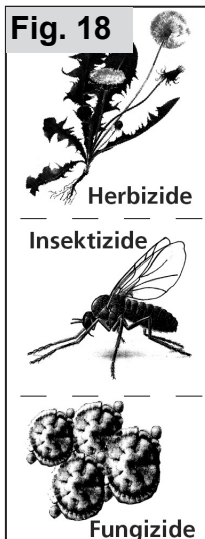

### Identification of the tank contents:

Attach the relevant sticker to the spraying agent tank to indicate the contents of the tank (i.e., herbicide, fungicide or insecticide).

The designation of the spraying agent used has to be attached to the device and has to be updated every time when the spraying agent is changed.

## 9 Use of the device

- Do not use the sprayer in wind or rain.
- Check the direction of the air movement before starting work and spray with the air movement, not against it.
- Do not spray towards persons, animals, open doors and windows, cars or other objects that may be hurt or damaged by the spray.
- Ensure that only the actual spray target will be wetted. Always aim to obtain even and homogenous distribution of the spray on the treated surfaces.

### Control panel (f)

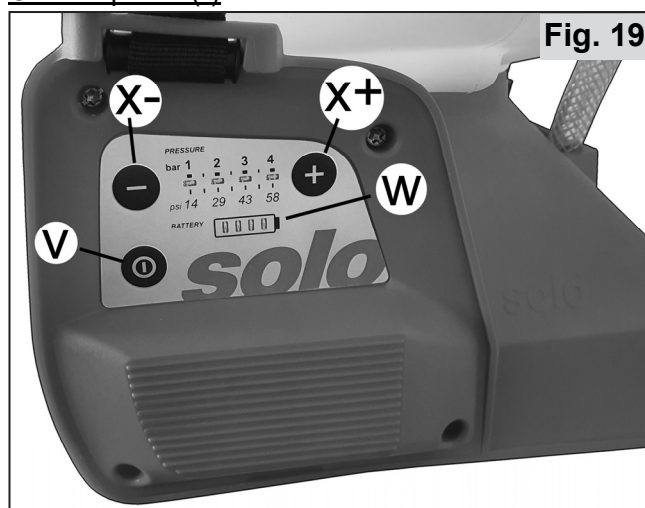

Switch the pump on and off with the on-off push button (v). When the pump is switched on, one to four LEDs light up on the "BATTERY" display (w), depending on the charge level of the battery. If the display flashes, the battery must be charged.

With the injection pressure selection push buttons (x+ / x-) the injection pressure is set in stages. The corresponding LED shows the set value.

### Spraying:

With the hand valve (**g**) closed (hand valve not activated), switch on the pump with the on-off push button (**v**). The pump starts up briefly until pressure has built up in the pressure chamber.

(Note: If there is air in the lines, the pump runs continuously. As soon as spraying begins, the lines are vented and the pump switches off when the hand valve (**g**) is closed.)

Set the desired spray pressure with the spray pressure selection push buttons (**x+** / **x-**). During spraying, the pump constantly provides the set spray pressure.

Put the sprayer on your back, adjust the shoulder strap correctly and close the chest lock.

Hold the spray wand with the hand valve.

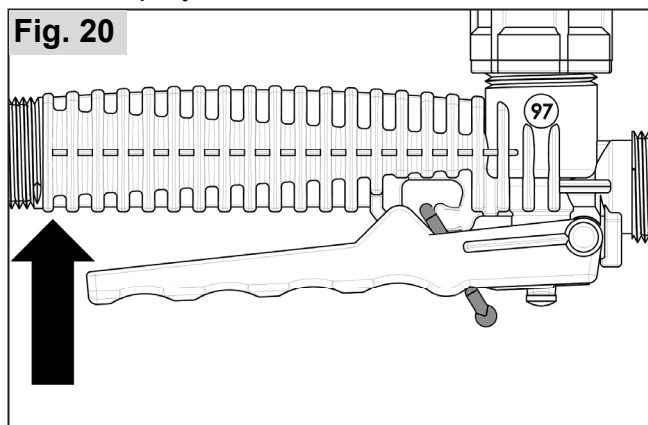

To spray, depress the hand lever on the valve. Release the hand valve lever to stop spraying.

To spray the underside of leaves, lightly loosen the spray wand cap nut and turn the wand hand tighten again.

An uneven spray picture or reduced spray output from the nozzle may require cleaning of the intake screen and nozzle (chap.10.3) or the replacement of these parts.

If the spray output is clearly reducing, end spraying and charge the battery. (chap. 7.4)

Always turn the pump off with the on-off push button (**v**) during work interruptions in which the device is taken off the back.

### **9.1 Disposal of residual spray volume**

Residual spray volumes of less than 200 ml [6.8 oz] are no longer pumped effectively. The electronics switch off automatically when the tank is empty. (Note: If the pump is then switched on again, the electronics will not switch off again and residues of spray agent can still be applied.)

Either add more spray formula and continue spraying or, when finishing off, dilute the residual volume with 2 litres [68 oz] of clean water and apply to the already treated area.

### **9.2 Ending spraying**

At the end of work, turn off the pump with the on-off push button (**v**).

In order to depressurise the device, keep the spray tube in the spraying agent tank or a suitable collection container with the pump turned off for the spraying agent until no liquid escapes anymore. Remove the battery and store it securely.

Empty and clean the device according to chap. 10.3, clean your face and hands thoroughly, take off work clothing and wash it regularly

## **10 Maintenance, cleaning and storage**

### **10.1 Maintenance plan**

#### Before starting work:

- Check the entire sprayer is operationally safe by:
  - Visual inspection of the sprayer
  - Checking the tightness of all parts (at maximum admissible pressure with the hand valve opened and closed).
  - Checking the working of all functional parts (control panel, hand valve).
  - Checking the hoses and their screw connections.
  - Visual inspection of the filter screen in the filler basket.

#### After the end of work, when changing the spray formula, whenever required:

- Cleaning the spray tank chap. 10.3
- Cleaning the nozzles chap. 10.3
- Cleaning the filter screen in the filler basket and the intake screen chap. 10.3

### **10.2 Test run**

When the spraying season starts and then every month, the following items must be checked in a test run with clean water:

- Tightness of all device parts in pump operation with the hand valve opened and closed
- Function of the hand valve; no spraying agent must escape with the hand valve closed (hand valve not actuated).

- Dosage and distribution accuracy

In case of irregularities, damage, leaks or limited function, do not use the sprayer but have it checked in a specialist workshop without delay.

### 10.3 Empty the spray tank and clean all the parts in the spray delivery system to the nozzle

Turn off the pump, depressurise the device, remove the battery, and store it securely. Empty the spray tank, flush with clean water all parts in the delivery system to the nozzle and the filter screen in the filler basket. Give special attention to the wear parts such as nozzles, filters and seals. Observe the cleaning notes in the original user manual for the chemical. Never use any aggressive, acid- or solvent-containing cleaning agents (e.g. petrol). After cleaning, let the spray tank dry in the open air.

Clean the spraying nozzle, filter screen in the filler basket and intake screen :

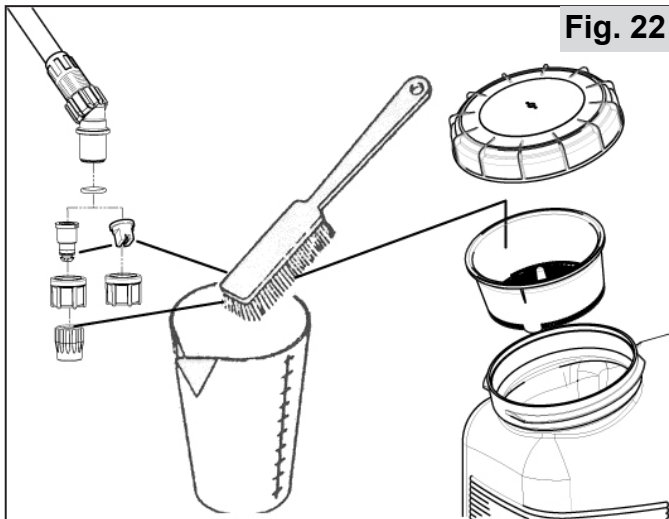

- Flush the nozzle assembly with clean water.
- Unscrew the nozzle assembly.
- Clean the O-rings, spray nozzle and filling screen with clean water and a soft brush. Never blow out the spray nozzle with the mouth! Never clean nozzles with hard objects!

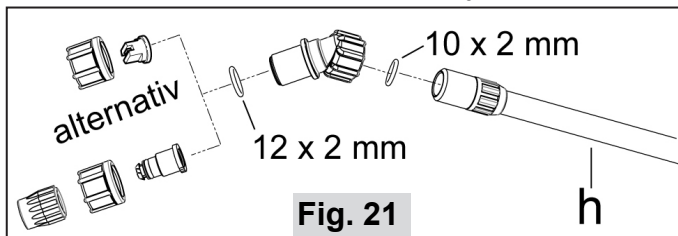

- Screw the parts of the nozzle assembly back together .

- Remove the intake screen (s) from the cleaned spray agent tank and clean with clean water and a soft brush.

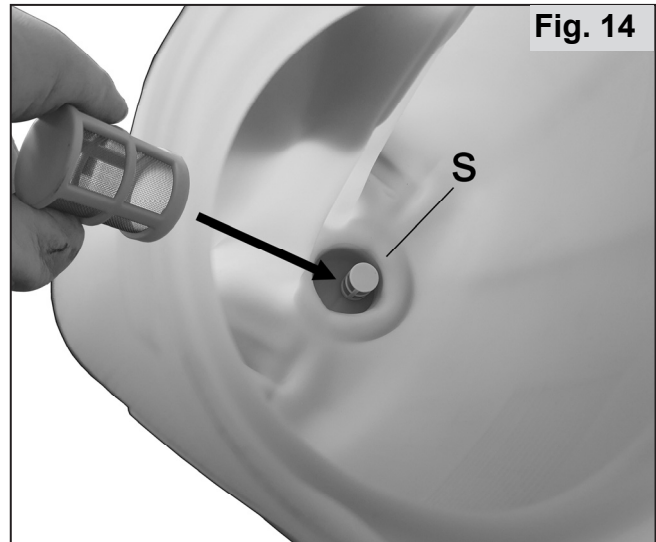

- Reattach the intake screen to the outlet connection to the pump in the spray agent tank .

### 10.4 Down periods and storage

Turn off the pump, depressurise the device, remove the battery, and store it securely. Empty and clean the sprayer according to chap. 10.3.

Put the battery in an insulating box (e.g. cardboard box, ideally the original packaging) and, like the device and the charger, store them in a dry, frost-free and safe place protected from sunlight at an ambient temperature of max. 35 °C [95 °F].

Prevent unauthorised use – especially by children.

## 11 Type plate

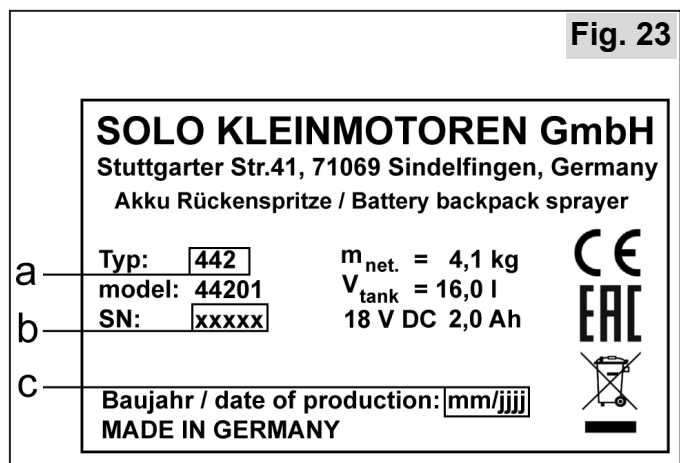

a: Type designation

b: Serial number

c: Manufacturing month/year



## 12 Technical data

Spray tank:	Total volume Max. fill volume	17.8 l [4.7 gal] 16.0 l [4.2 gal]
Residual volume, (remaining liquid in tank that cannot be used)		< 200 ml [6.8 oz]
Pump system		SOLO Diaphragm pump
Operating pressure		1 / 2 / 3 / 4 bar 14 / 29 / 43 / 58 psi
Permissible operating temperature		4 – 45 °C [39 – 104 °F]
Pressure hose:	Length	1,300 mm [51.2"]
Application volume		<b>l/min</b> <b>USgal/min</b>
with standard spraying nozzle	1 bar [14 psi]	0,68      0.180
with standard spraying nozzle	2 bar [14 psi]	0,97      0.256
with standard spraying nozzle	3 bar [14 psi]	1,19      0.314
with standard spraying nozzle	4 bar [14 psi]	1,37      0.362
adjustable hollow cone nozzle	1 bar [14 psi]	0,44 – 1,10      0.116 – 0.290
adjustable hollow cone nozzle	2 bar [14 psi]	0,55 – 1,45      0.145 – 0.383
adjustable hollow cone nozzle	3 bar [14 psi]	0,66 – 1,75      0.174 – 0.462
adjustable hollow cone nozzle	4 bar [14 psi]	0,75 – 1,95      0.198 – 0.515
Filling screen:	Mesh gauge	1.8 mm [0.071"]
Intake screen (stainless steel)	Mesh gauge	0.35 mm [0.014"]
Weight:	Ready for operation, empty w/o battery Ready for operation, with max. filling volume	4,1 kg [9.0 lbs] 20,5 kg [45.2 lbs]
Dimensions (without spray wand, and pressure hose):	height Width Depth	561 mm [22.1"] 397 mm [15.6"] 277 mm [10.9"]
Rechargeable battery (Li-Ion):	Permissible operating temperature Rated voltage Capacity Energy content Battery name (EN 61960)	4 – 45 °C [39 – 104 °F] 18 V 2.5 Ah 46.25 Wh 51NR19/65
Battery charger:	Permissible operating temperature Charger input:      AC 50 Hz – 60 Hz Output voltage:      20 V DC Number of battery cells Battery capacity Protection class	4 – 45 °C [39 – 104 °F] 100 – 240V 2 A 3 – 10 2,0 Ah – 5,0 Ah IP 20 / II
Charging time with minimum initial battery charge		Approx. 1.1 h
Max. operating time with standard nozzle with operating pressure 1 bar [14 psi] per charging cycle		Approx. 6 h
Sound pressure level <sup>1</sup> L <sub>Peq</sub> according to EN ISO 3744		< 70
Sound power level <sup>1</sup> L <sub>W<sub>eq</sub></sub> according to    EN ISO 3744		< 70
Weighted effective acceleration <sup>1</sup> a <sub>h<sub>v</sub>,eq</sub> according to    EN ISO 5349		< 2,0

<sup>1</sup> In determining the above mentioned values regarding the acceleration of vibrations and sound, the different operating conditions were weighted in accordance with the current standards.





# **solo**<sup>®</sup>

Made in Germany



**SOLO Kleinmotoren GmbH**

Industriestraße 9

D-71069 Sindelfingen

Postfach / PO Box 60 01 52

D-71050 Sindelfingen

DEUTSCHLAND / GERMANY

Tel.: +49 (0)7031 301-0

Fax: +49 (0)7031 301-202

[info@solo-germany.com](mailto:info@solo-germany.com)

<http://solo.global>