

### **Originalbetriebsanleitung**

*Gebrauchsanweisung*

### **Original instructions**

*Instruction manual*

### **Notice originale**

*Instructions d'emploi*

### **Manual original**

*Manual del usuario*

### **Istruzioni originali**

*Istruzioni d'impiego*

### **Oorspronkelijke gebruiksaanwijzing**

*Gebruiksaanwijzing*

### **Achtung!**

Lesen Sie vor der ersten Inbetriebnahme diese Gebrauchsanweisung gründlich durch und beachten Sie unbedingt die Sicherheitsvorschriften!

### **Important!**

Read this instruction manual carefully before first operation and strictly observe the safety regulations!

### **Attention!**

Lire attentivement ce manuel avant la première mise en service et observer absolument les prescriptions de sécurité!

### **¡Atención!**

Es indispensable leer con mucha atención las instrucciones de manejo antes de utilizarla por primera vez. ¡Preste especial atención a las recomendaciones de seguridad!

### **Attenzione!**

Prima della prima messa in funzione leggere a fondo le presenti istruzioni per l'uso e osservare assolutamente le norme di sicurezza.

### **Attentie!**

Lees deze gebruiksaanwijzing aandachtig door voordat u de machine in gebruik neemt en sla acht op de veiligheidsvoorschriften!

### **Laubbläser**

### **Leaf blower**

### **Souffleur de feuilles**

### **Soplador de hojas**

### **Soffiatori di fogliame**

### **Bladblazer**



de

en

fr

es

it

# Instruction manual

## Original instructions

 **Caution!** Prior to operating the unit, please read the owner's manual carefully, and most importantly, observe all safety rules.

Observe the maintenance guidelines closely to ensure the long service life of your equipment.

Your dealer will be glad to assist you with any questions.

Information about material ingredients (VO (EC) No.1907/2006 „REACH“)

can be found on our homepage under:

<https://de.solo.global/de/content/12-service>

### Exhaust emission level

The CO2 value determined in the EU type-approval process can be found on our homepage under:

<https://de.solo.global/de/content/12-services>

### Packaging and disposal

Please keep the original packaging in order to protect the equipment against transport damage in case you ever need to ship it or transport it.

The original packaging and the leaf blower (at the end of its service life) must be properly disposed of according to the local environmental regulations.



For **USA** only:

### Emissions Control Warranty Statement

The Environmental Protection Agency and Solo are pleased to explain the emission control system on your small non-road power equipment engine. In the US new small non- road engines must be designed, built, and equipped to meet the Environmental Protection Agency's standards. Solo must warrant the emission control system on your small non- road engine for the period of time listed below provided there has been no abuse, neglect, or improper maintenance of your small non-road engine.

Your emission control system includes parts such as the carburetor, the ignition system, and the exhaust system.

Where a warrantable condition exists, Solo will repair your small non-road power equipment engine at no cost to you including diagnosis, parts, and labor.

### Manufacturer's Warranty Coverage

Solo's small non-road power equipment engines are warranted for a period of two years. If any emission control related part on your engine is defective, the part will be repaired or replaced by Solo.

### Contact Information for Authorized Service Center

#### Locations, Replacement Parts,

#### Warranty and Technical Information

Warranty repairs **must** be completed by a SOLO Authorized Service Center.

SOLO USA, Inc.

5100 Chestnut Avenue

Newport News, VA 23605

1-800-765-6462

techserv@solousa.com

## 1. Symbols

The following symbols are used in this manual and on the product:



Thoroughly read these operating instructions before undertaking any maintenance, installation and cleaning steps



Always handle this power tool with particular care



Wear the prescribed protective clothing.



Wear ear defenders before starting the engine



Wear face protection (e.g., safety goggles).



Wear protective gloves when handling and working with the equipment



Use a breathing mask if necessary



Petrol is highly flammable



Keep open flames away from the power tool and the fuel can



Do not smoke



No-one else may remain in the vicinity of the motor appliance whilst it is operating.



Switch off engine



choke open



Choke partially open  
Warm-up



choke closed

## 2. Type plate

<b>SOLO KLEINMOTOREN GmbH</b>		
Industriestraße 9, 71069 Sindelfingen, Germany		
<b>Blasgerät / Leaf Blower</b>		
a	Typ: <b>468</b>	m <sub>net.</sub> = 8,4 kg
	model: <b>46801</b>	
b	SN: <b>xxxxx</b>	
	e1*2016/1628*2016/1628SHB3/P*0181*00	
c	Baujahr / date of production: <b>mm/jjjj</b>	
<b>MADE IN GERMANY</b>		
		

a: Type designation

b: Serial number

c: Build year

### 3. Safety regulations





 This machine produces an electromagnetic field during operation. This field may under some circumstances interfere with active or passive medical implants. Persons with medical implants have to consult their physician and the medical implant manufacturer before operating this machine. You should request and receive instructions from the vendor on the safe operation if you are using this type of product for the first time.

#### 3.1 Correct use / General safety instructions





Always observe all safety hints while using the machine.

The blower unit is suitable for the removal of leaves, grass, paper, dust or snow in areas such as gardens or parks, sports facilities, parking areas or drives. The blower can also be used for the removal of leaves and small branches while harvesting stone fruit.

**The blower unit may only be used for the purpose it has been designed for– and no other!**

-  For despatch purposes, the blower is supplied partially disassembled and has to be fully assembled prior to use. (chapter 3 “Assembly”) The blower may only be operated when fully assembled.
-  Read the operating instructions carefully before placing in service and keep them in a safe place. First time users should be instructed by the seller or an expert.
-  Within the scope of the units operating area, the operator is responsible for injuries to other persons. Operate the blower only when in good physical condition. Fatigue or ill health may lead to lack of attention and care. The machine should be operated in a calm and alert manner.
-  Never operate the blower when under the the influence of alcohol or drugs. The air exit speed from the nozzle is very high. Never point the nozzle towards persons or animals.

#### 3.2 Personal protective equipment for your safety

-  To prevent injuries to head, eyes, hand, feet or damage to hearing, the following protective equipment should be worn:
-  Clothing should be appropriate for the job, i.e. not too loose and not too tight to be hindering. Do not wear work coat, shorts or sandals. The operator should not wear a scarf, a necktie or jewelry which may get caught by branches.
-  Protect your face and eyes with a face guard or safety glasses.
-  To avoid damage to hearing, the operator should wear suitable personal noise protection such as ear muffs, ear plugs or similar.

Wear firm work shoes with non-slip soles.

Always observe accident prevention regulations issued by local trade organizations or workers compensation boards.

#### 3.3 Protection of Environment

**Be aware of your surroundings**

- Watch out for animals which may be within your work area
- Be aware that noise is harmful to the environment. Inquire about and respect possible local rest periods.

#### 3.4 Operating Hints

- Approach blowing task with engine at idling speed, then accelerate to full throttle.
- No other persons should be present within a circle of 15 meters from the operator. Watch out for children and animals. Objects carried by the air stream can deflect and injure nearby persons.
- Never operate on unstable ground watch out for any obstacles such as tree stumps, tree roots, ditches etc..
- Take special care while working along slopes.
- Never touch a hot exhaust.

**4. Important Components**

1.	On/Off Switch	<b>Fig. 1</b>
2.	Throttle Lever	
3.	Throttlet control lock	
4.	Primer	
5.	Choke Lever	
6.	Air Filter Cover	
7.	Fuel Tank Lid	
8.	Starter Handle	
9.	Spark Plug	
10.	Muffler	
11.	Carburetor Adjustment Screws	
12.	Carrying Strap	
13.	Quick-Release Carrying Strap	
14.	Carrying Frame	
15.	Blower Housing	
16.	Blower Elbow	
17.	Pleated Elbow Tube	
18.	Blower Tube I	
19.	Extension Tube II	
20.	Curved Nozzle Tube	

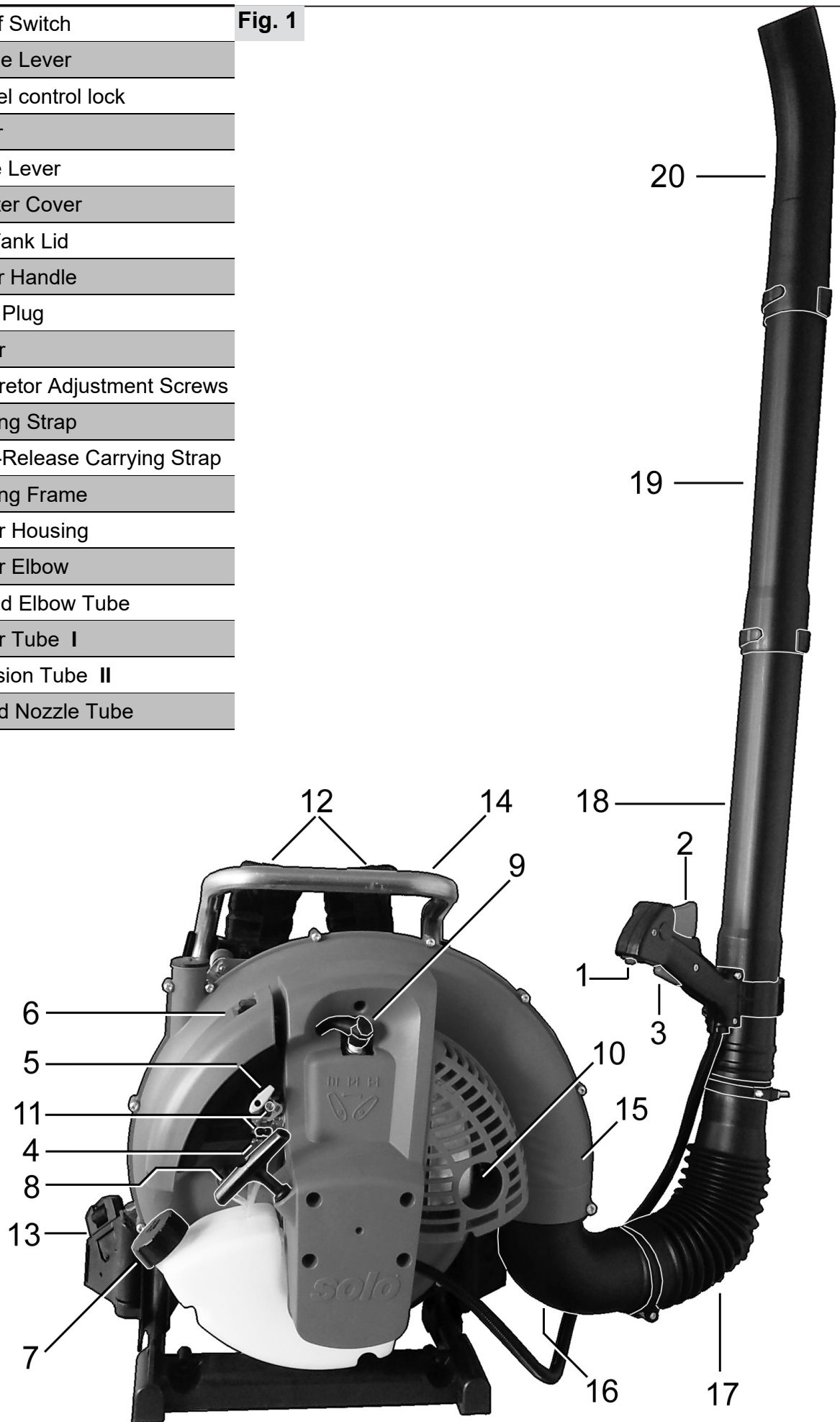



5. Assembly

Completely assembly the leaf blower before its first use:

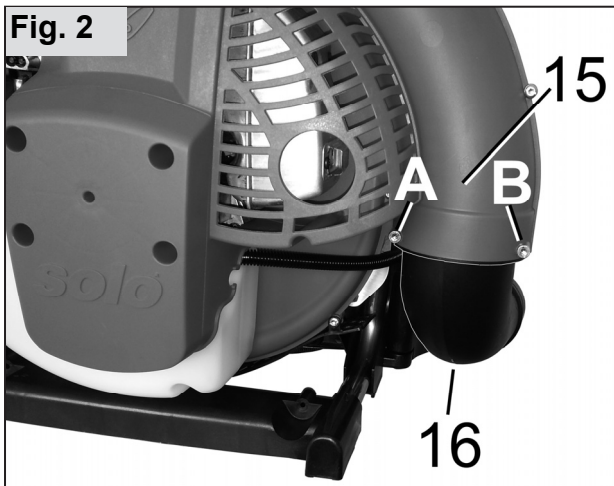

The blower elbow (16) is already fixed in the blower housing (15) with the two screws (A+B). Ensure the elbow can swivel easily.

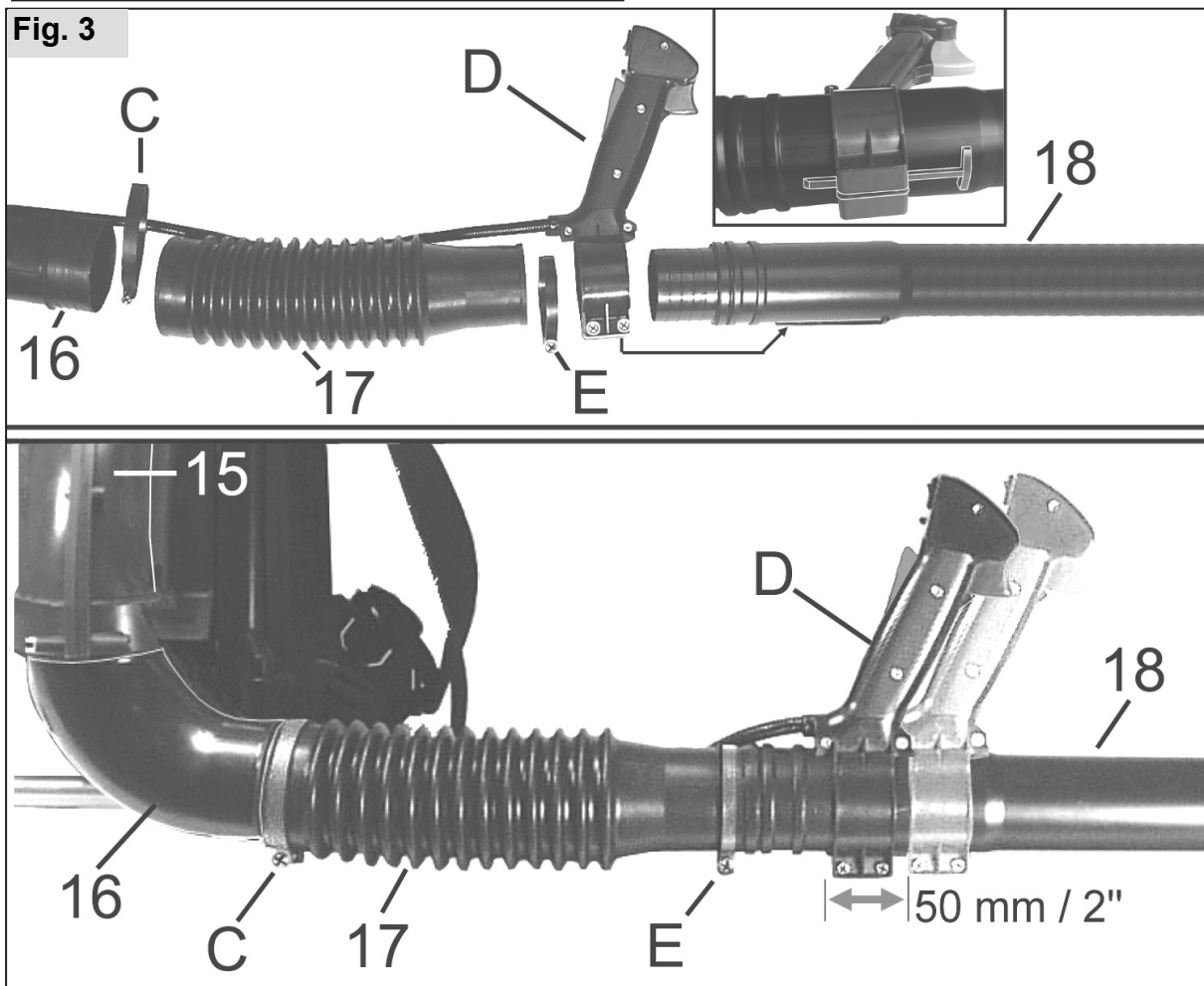

Push pleated elbow tube (17) onto blower elbow (16) and secure with clamp (C).

Push multi-function handle (D) onto blower tube I (18) and fix with 2 screws in the required, comfortable position. The adjustment scope is approx. 50mm depending on the arm length of the operator.

Push blower tube I (18) into pleated elbow tube (17) and secure with plastic clamp (E).

**Note:** With the multi-function handle the blower tube can now be twisted and swiveled in the pleated blower elbow. Ensure that no cables are disconnected when testing this feature.

Insert extension tube II (19) in blower tube I (18) and secure with twist lock.

Push curved nozzle tube (20) on extension tube II (19) and also secure with twist lock.

## 6. Fuelling



### 6.1 Safety instructions fuelling

- The handling of fuel requires caution and consideration. It is imperative that all safety instructions are observed!
- Smoking or open flame is prohibited.
- Allow engine to cool before re-fueling.
- Fuel may contain solvent-like substances. Avoid skin and eye contact with mineral products. Wear gloves while refueling. Frequently change and clean protective clothing. Do not inhale fuel vapors.
- Do not spill fuel or oil. In case of spillage, immediately wipe off the power tool. Do not allow fuel mix to contact clothing. If fuel mix is spilled on clothing, change clothing immediately
- Ensure fuel or oil do not contaminate soil (environmental protection). Always use a suitable protective soil cover.
- Do not re-fuel in unventilated rooms. Fuel vapors collect at ground level (danger of explosion).
- Transport and store fuel and oil only in approved and clearly marked containers. Children should have no access to fuel or oil.

### 6.2 Fuel information

A high performance two-stroke engine operated with a petrol:oil mixture (petrol + oil = fuel mixture) or with a special fuel mixture for two-stroke engines available from specialists powers this machine.

We recommend the proprietary "**Aspen 2-takt**" special fuel mixture. Please observe the special fuel manufacturer's instructions.

#### Information on individual mixing of the fuel mixture

The fuel mix must be formed from the following components:

- Lead-free regular petrol or lead-free super petrol with a minimum octane number of 92 RON.
- Branded 2-stroke engine oil corresponding to the standard ISO-L-EGD or JASO FD

Recommendation:

Use the "SOLO Profi 2-stroke engine oil" at a mixing ratio of oil:petrol of 1:50 (2 %).

Store the fuel mix no longer than 3 weeks.

### Mix table for fuel mix:

Oil:petrol ratio = 1:50 (2 %)	
Branded 2-stroke engine oil	Petrol
20 ml	1 l
40 ml	2 l
100 ml	5 l
200 ml	10 l

Unsuitable petrol or deviations in the mixing ratio may lead to serious engine damage!

Avoid direct skin contact with petrol and avoid inhaling petrol fumes - health hazard!

### 6.3 Fuelling

While fuelling always follow all safety instructions and take all safety precautions.

Handle fuel only with the engine turned off. Carefully clean the area around the filler inlet. Place the machine with the fuel inlet pointing upwards. Unscrew the tank lid and fill the fuel mixture up to the lower edge of the filler neck. Use a funnel with filter to prevent tank contamination. After filling the tank replace the tank lid and tighten firmly.

## 7. Starting / Stopping the engine





### Starting with cold engine

Fig. 4



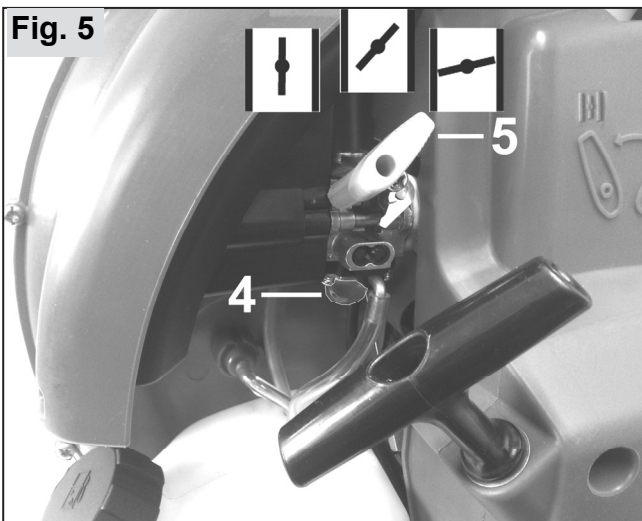

- Switch On/Off Switch (1) to "I" position.



 Close choke with choke lever (5).

- Press primer (4) several times until fuel is visible in the primer.
- Hold the machine with your left hand on the carrying handle (15). With the right hand, slowly pull out the starter handle (8) until resistance is felt. Then pull quickly and forcibly until the engine attempts to start (engine fires).

 If the engine "tries" to start (ignite), set the choke in the middle position (partially open) and if necessary repeat the starting procedure. In very cold ambient temperature, let the engine with the choke in the middle position (partially open) warm up briefly.

 As soon as the engine runs smoothly, set the choke in the open position.

### Starting with warm engine after short stop

- Start the engine with choke in open position.

Should the engine refuse to start despite several starting attempts, the combustion chamber is most likely flooded.

In this case we recommend you remove and dry the spark plug (9). Set the ignition switch to "0". Pull over engine several times, still with spark plug removed. This will ventilate the combustion chamber

Replace spark plug and repeat starting procedure.



### Shutting off engine

- Release throttle lever and move throttle lock lever to "min" position.
- After full load running bring the engine to idle for 20sec to cool down.
- Move ignition switch to "0" position until engine stops.

## 8. Operating Hints



Prior to operating and prior to each start, check the blower unit's condition with regard to throttle activation, on/off switch, protective covers, carrying straps and also for any fuel leaks.

Take care not to inhale exhaust fumes. Do not operate the blower in closed areas.

- Prior to starting the engine and during all jobs, the operator needs to be securely and safely positioned.
- The engine starting site should be at least 3 meters away from the refueling site.

### 8.1 Adjustment of shoulder straps

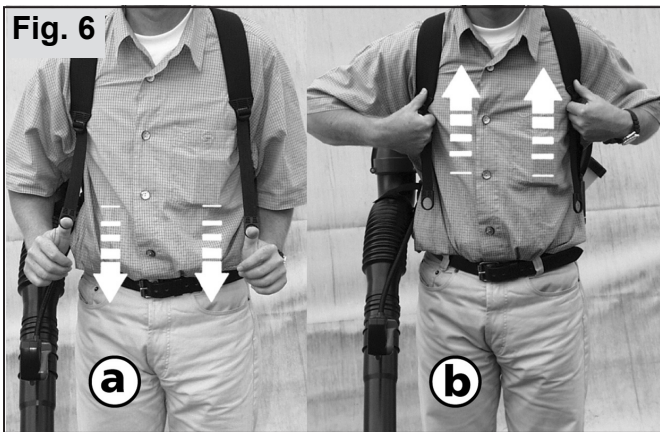

Put blower on back and secure carrying straps with quick-coupling locks (13).

The straps can be adjusted to the required length with friction slides. Simply pull down both strap ends to tighten straps (a).

Strap tension can be released by lifting both friction slides (b).

#### Note:

The shoulder straps are correctly adjusted when the back plate rests firmly against the back of the operator.

### 8.2 Active components of the operating handle

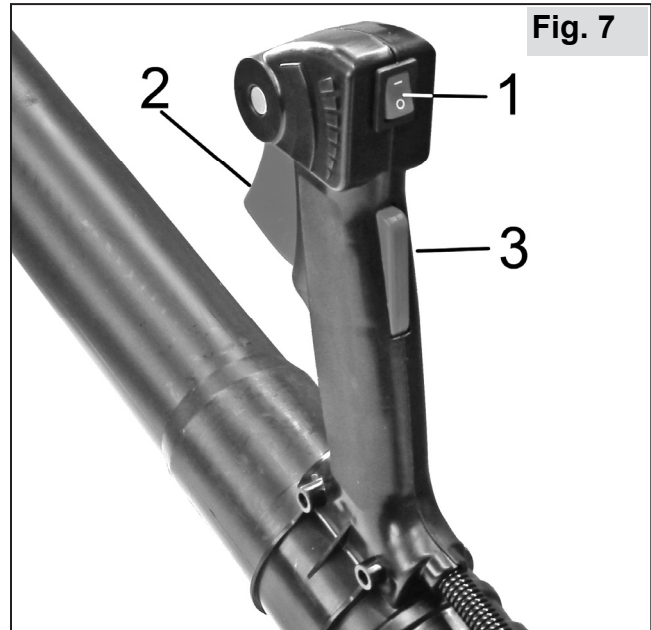

To release the throttle control (2):  
 Hold the handle with your right hand,  
 → the throttle control lock (3) is activated by the flat of your hand,  
 → the throttle control is released.

On/Off Switch (1) "I" → operating position

On/Off Switch (1) "0" → engine off



## 9. Maintenance and care

Maintenance and repair of modern motorized devices, as well as their safety-relevant assemblies, require qualified, specialized training and a workshop equipped with special tools and test devices. Thus SOLO recommends that you have a specialized SOLO workshop carry out all work that is not described in these operating instructions. Your SOLO specialist has the required training, experience, and equipment at his disposal to provide you with the most cost-effective solution and can help you in many ways with advice and service.

### 9.1 General Maintenance Hints



After a running in period of approx. 5 hours, all accessible screws and nuts (except for carburetor mixture adjustment needles) have to be checked and re-tightened if required. Any service jobs, other than those described in this manual, should only be carried out by an authorized service center.

- Any cleaning, maintenance or repair jobs should only be performed when the engine is stopped and with removed spark plug cap. The exception, of course, is carburetor tuning

#### Maintenance Guide Lines

- Any service jobs, other than those described in this manual, should only be carried out by an authorized service center. Only original parts may be used for any maintenance and service work.
- Never modify your leaf blower – your personal safety is at risk.
- Never service or store the machine near an open flame.
- Regularly check the fuel tank lid for sealing and tank ventilation. Only use recommended spark plugs. Check ignition cable for any damage.
- Do not operate the blower with a broken or removed muffler. This can lead to fires and cause hearing damage. Do not touch hot muffler.
- For transport in a vehicle, ensure the power tool is well secured to avoid fuel spillage.
- Completely empty the fuel tank before extended storage or shipment.

### 9.2 Carburettor adjustment



The carburettor is adjusted at the factory for optimum performance. Subject to the place of use (mountains, low-lying areas), the average idling speed given in the specification can be adjusted as follows, via the idling end-stop screw "T" (the use of a rev counter is recommended):

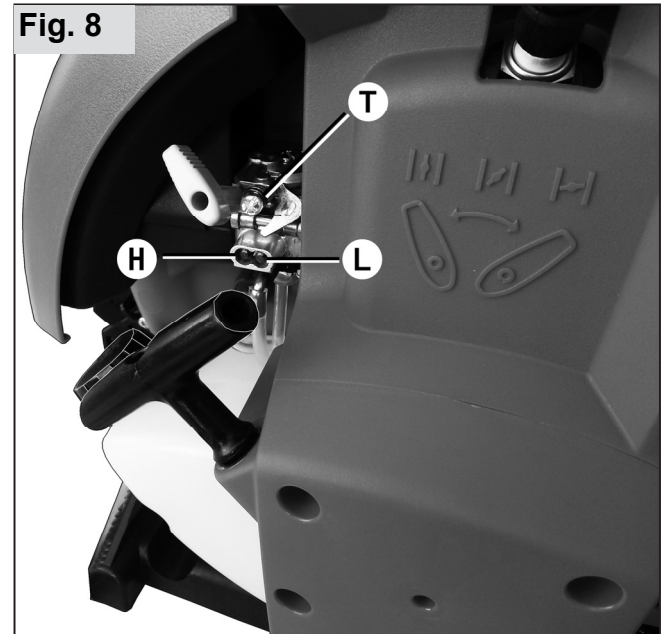

- If the idling speed is too high, turn the idling end-stop screw "T" anti-clockwise.
- If the idling speed is too low (engine stops) turn the idling end-stop screw "T" clockwise until the engine runs smoothly.

If the idling speed cannot be set correctly with the idling end-stop screw "T", request an authorised service centre to tune the carburettor.

**The adjusting screws for the idling mixture "L" and the full-load mixture "H" must only be adjusted by an authorised workshop.**

### 9.3 Air Filter Maintenance



The air filter separates and retains dirt before the air reaches the combustion chamber. This reduces engine wear.

Regular maintenance increases engine life.

Clogged air filters cause performance loss and increased fuel consumption. This leads to a higher toxin level in the exhaust gas and also makes starting more difficult.

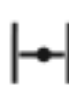
 Before opening the air filter housing, close the choke to prevent dirt entering the carburettor.

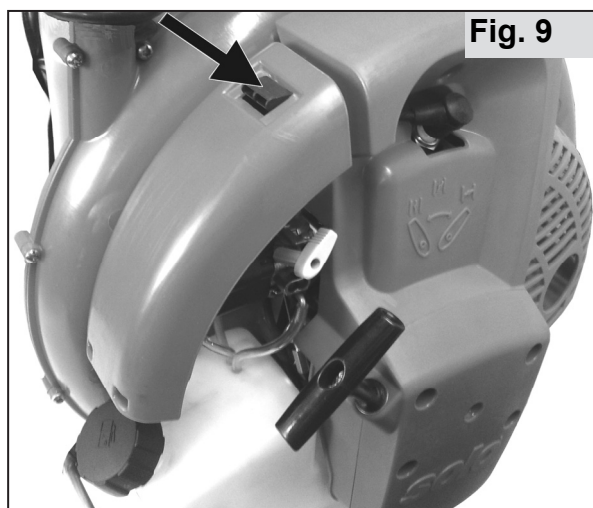

Fig. 9

To open the air filter housing press in the black clamp and open the housing cover downwards.

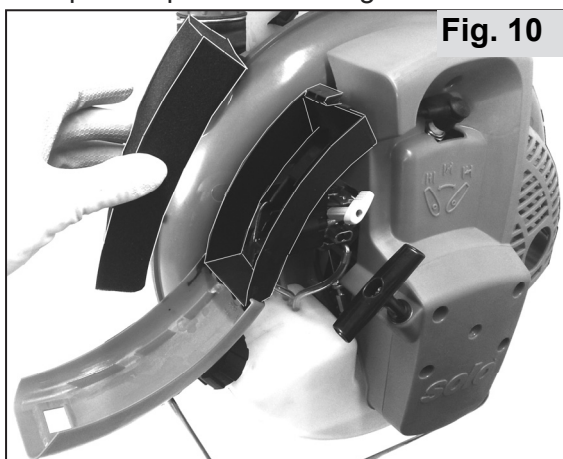

Fig. 10

Remove foam filter.

When the machine is used all day, the air filter should be cleaned daily. In severe dust conditions clean more often in between.

For daily cleaning:

Tap the air filter against an object or use an air gun.

With heavy dust conditions and for normal weekly check:

Wash a heavily soiled filter in non-flammable cleaning solvents (warm soapy water).

Wipe the air cleaner housing clean with a dry or slightly damp cloth. Before inserting the filter, the

housing and the filter must be completely dry again.

Never insert moist or wet foam filters!

Immediately replace damaged filter parts.

When re-fitting, ensure the filter is positioned and seated properly.

If the filter material is damaged, replace the corresponding parts immediately.

Warranty claims cannot be accepted for damaged engine parts caused by improper care and maintenance.

### 9.4 Spark Plug



The correct spark plug with thermal range 200 is available under the following brands:

**BOSCH**      **WSR6F**

**CHAMPION**   **RCJ-6Y**

**NGK**         **BPMR7A**

The correct electrode gap is 0.5 mm.



Check the plug after every 50 operating hours and replace if electrodes are worn.

### 9.5 Shutdown and storage



Clean the power tool after use.

- Never use aggressive cleaning solutions or those containing solvents to clean any part of the engine. Never hose down the engine. For best results, simply wipe down the entire engine with a dry or slightly damp cloth.

Store the device in a dry, safe location inside a building (garage, basement, ...). There must not be any open fires or similar nearby. Ensure that the device cannot be used by unauthorised persons, especially children.

If not in use for more than four weeks, drain the fuel tank in a well ventilated location before storing. Start the engine with an empty fuel tank and drain the carburettor until the engine stops. Oil residues from the fuel mixture could otherwise clog the carburettor jets and make it difficult to start the device later.







## 9.6 Scheduled maintenance



The following information is based on standard operating conditions. For special conditions, such as prolonged daily use, the recommended maintenance intervals should be reduced accordingly.

Implement all maintenance jobs regularly. If required, authorise a specialist service centre to maintain the machine for you. The owner of the machine is responsible for:

- Any damage caused by a lack of maintenance, incorrect or late maintenance and repairs
- Consequential losses - including corrosion - from incorrect storage

		after the first 5 hours	before starting work	after every 50 hours	after every 100 hours	as required	once per year
<b>Carburettor</b>	Check idling speed		X				
	Adjust idling speed					X	
 <b>Air filter</b>	Clean		X				
	Replace					X	
 <b>Spark plug</b>	Check electrode gap and replace spark plug if required			X			X
	Replace				X	X	
 <b>All accessible screws</b> (except for adjusting screws)	Retighten	X				X	X
<b>Controls</b> (stop switch, throttle lever, starter)	Check function		X				
 <b>Silencer</b>	Visual inspection		X				
 <b>Air inlet</b> (Protection screen)	Clean			X		X	X
 <b>Complete machine</b>	Visual inspection		X				
	Clean			X		X	X

Furthermore, as part of the annual service at an authorised dealer, request the following services:

- Complete check of the entire machine
- Professional cleaning of the engine (fuel tank, cylinder head fins, ...)
- Check and, if necessary, replace wearing parts, particularly the annual fuel filter change
- Optimum setting of the carburettor

## 9.7 Replacement parts

Dependable operation and the safety of your device also depend on the quality of the replacement parts that you use. Use only original SOLO replacement parts. Only original parts come from the production of the device and thus guarantee the highest possible material quality, dimensional accuracy, function, and safety. Original replacement parts and accessory parts are available from your dealer. He also maintains the requisite replacement part lists to determine the required replacement part numbers, and he is constantly provided with information concerning detail improvements and innovations in the replacement part offering. Please note as well that guarantee performances from SOLO are not possible if parts other than SOLO original parts are used.

## 10. Technical Specifications

Leaf blower		468
Engine type		SOLO single cylinder two-stroke engine
Engine capacity	cm <sup>3</sup>	66.5
Bore / stroke	mm	46 / 40
Max Engine power (ISO 8893)	kW	2.1
Fuel tank capacity	l	1.4
Fuel mix ratio	with <b>SOLO 2T engine oil</b>	1:50 (2%)
Carburettor		All-position diaphragm carburettor with primer and integrated fuel pump
Air filter cartridge		Foam filter
Ignition		Electronically controlled magneto ignition, maintenance free
Max. Blower Air Volume *	m <sup>3</sup> /h	1400
Max. Air Speed	m/s	92
Medium idling speed	rpm	2700 ± 200
Permissible speed	rpm	6000 ± 200
Sound level <sup>1,2</sup> L <sub>Peq</sub> (EN ISO 22868)	dB(A)	95
Sound power level <sup>1,2</sup> L <sub>W</sub> (EN ISO 22868)	dB(A)	107
Weighted effective acceleration on handle <sup>1,3</sup> (EN ISO 22867)	m/s <sup>2</sup>	≤ 2.5
Weight	kg	8.4
Dimensions without Tube	mm	high: 500 / width: 493 / depth: 292

<sup>1</sup> In determining the above mentioned values regarding the acceleration of vibrations and sound, the different operating conditions were weighted in accordance with the current standards.

<sup>2</sup> Insecurity K purs. to EC directive 2006/42/EC: 2.5 dB(A)

<sup>3</sup> Insecurity K purs. to EC directive 2006/42/EC: 2 m/s<sup>2</sup> [78.7 "/s<sup>2</sup>]

\* without Tube

## 11. EC declaration of conformity

SOLO Kleinmotoren GmbH, Industriestraße 9, 71069 Sindelfingen, GERMANY, declares that the following machine as delivered complies with the provisions in implementation of the following EC directives: 2006/42/EG, 2000/14/EC, 2014/30/EU and 2011/65/EU

Product designation: Leaf Blower, Trade designation: SOLO 468,  
Type designation 46801, Engine capacity 66.5 cm<sup>3</sup>

Applied standards: EN ISO 12100, EN ISO 15503, EN 14982

From production date 10/2019 onwards

Sound power level pursuant to 2000/14/EC: warranted: 110 dB(A), measured: 107 dB(A)

Storage site for the technical documents pursuant to 2000/14/EC and 2014/30/EU:  
SOLO Kleinmotoren GmbH, Industriestraße 9, 71069 Sindelfingen, GERMANY



SOLO Kleinmotoren GmbH, Industriestraße 9, D-71069 Sindelfingen, 01<sup>st</sup>. April 2020  
Andreas Emmerich (managing director and documentation officer),



## 12. Parts subject to tear and wear

Various parts are subject to application- specific or normal wear and must be replaced in good time, when required. The following parts are subject to normal wear and are not covered by the manufacturer's guarantee:

- Air filter
- Fuel filter
- All rubber parts which come into contact with fuel
- Spark plug
- Starter

## 13. Guarantee

SOLO guarantees problem-free quality and will assume the costs for defect remediation by replacing the defective parts in the case of material or manufacturing defects that occur within the guarantee period after the date of purchase. Please note that specific guarantee conditions apply in some countries. Ask your sales person if you have any questions. As vendor of the products he is responsible for the guarantee. We request your understanding that no guarantee can be assumed for damages due to the following:

- Non-compliance with the operating instructions.
- Neglecting required maintenance and repair work.
- Damages due to improper carburetor adjustment.
- Normal wear and tear.
- Obvious overload through persistently exceeding the upper performance limits.
- Using non-approved tools and cutting fixtures, Using non-approved cutting bar and chain lengths in the case of chain saws.
- The use of force, improper handling, misuse, or accident.
- Damages caused by overheating due to dirt build up on the ventilator casing.
- Intervention by non-specialized persons, or improper repair attempts.
- The use of unsuitable replacement parts or parts other than SOLO original parts to the extent that they cause damage.
- Using unsuitable fuel or fuel that has been stored too long.
- Damages that can be traced to implementation conditions from the rental business.

Cleaning, care, and adjustment work are not recognized as guarantee performances. All guarantee work must be carried out by a SOLO dealer.

### For Australia only: Supplementary warranty notes specifically for Australia

To make a claim, contact Clayton Engineering, 26 French Ave, Brendale, Q, 4500 on phone 1300 798 022 or email [sales@claytonengineering.com.au](mailto:sales@claytonengineering.com.au). You will be asked to provide proof of purchase and then will be instructed on the procedure for repairing or replacement of the product under warranty. All costs incurred for repair or replace, and additional claims can be discussed at this stage.

This warranty is provided in addition to other rights and remedies you have under law: Our goods come with guarantees that cannot be excluded under the Australian Consumer Law. You are entitled to a replacement or refund for a major failure and for compensation for any other reasonably foreseeable loss or damage. You are also entitled to have the goods repaired or replaced if the goods fail to be of acceptable quality and the failure does not amount to a major failure.

In the best interest of continued technological progress we reserve the right to change the design and configuration of any product without prior notice.

For that reason, no claims can be accepted with reference to text and illustrations in this manual

# **solo**<sup>®</sup>

Made in Germany



**SOLO Kleinmotoren GmbH**

Industriestraße 9

D-71069 Sindelfingen

Postfach / PO Box 60 01 52

D-71050 Sindelfingen

DEUTSCHLAND / GERMANY

Tel.: +49 (0)7031 301-0

Fax: +49 (0)7031 301-149

info@solo-germany.com

<http://solo.global/>