

solo[®]

416 Li

Originalbetriebsanleitung
Gebrauchsanweisung

Original instructions
Instruction manual

Notice originale
Instructions d'emploi

Manual original
Manual del usuario

Istruzioni originali
Istruzioni d'impiego

**Oorspronkelijke
gebruiksaanwijzing**
Gebruiksaanwijzing

Achtung!

Lesen Sie vor der ersten Inbetriebnahme diese Gebrauchsanweisung gründlich durch und beachten Sie unbedingt die Sicherheitsvorschriften!

Important!

Read this instruction manual carefully before first operation and strictly observe the safety regulations!

Attention !

Lire attentivement ce manuel avant la première mise en service et observer absolument les prescriptions de sécurité !

¡Atención!

Es indispensable leer con mucha atención las instrucciones de manejo antes de utilizarla por primera vez. ¡Preste especial atención a las recomendaciones de seguridad!

Attenzione!

Prima della prima messa in funzione leggere a fondo le presenti istruzioni per l'uso e osservare assolutamente le norme di sicurezza.

Opgelet!

Lees deze gebruiksaanwijzing grondig voor u de machine voor het eerst gebruikt en hou altijd rekening met de veiligheidsvoorschriften!

Akku-Druckspritze

**Pressure sprayer with
rechargeable battery**

Pulvérisateur à batterie

**Pulverizador a presión
con batería**

Spruzzatore a batteria

Accu-drukspuit



Abbildung → modellabhängig
Illustration → depending on the version
Illustration → selon la version
Imágene → según versión
Figurre → a seconda del modello
Afbeelding → afhankelijk van de uitvoering



de

en

fr

es

it

nl

Instruction manual

Original instructions



Caution!

Prior to operating the unit, please read this instruction manual carefully, and most importantly, observe all safety rules.

To ensure that your device will continue to work properly and deliver optimum performance for many years to come, ensure that you follow all operating and maintenance instructions.

Your authorised SOLO dealer will be glad to assist you with any questions.

Information about material ingredients (VO (EC) No.1907/2006 „REACH“) can be found on our homepage under: <https://de.solo.global/de/content/12-service>

EC declaration of conformity

The EC declaration of conformity on a separate piece of paper forms part of these operating instructions.

Packaging and disposal

Please keep the original packaging in order to protect the equipment against transport damage in case you ever need to ship it or transport it. If the packaging materials are no longer required then they must be disposed of properly in accordance with applicable local regulations. Cardboard packaging materials are raw materials which can be recycled or reused.

At the end of the equipment's service life, please make sure that you dispose of it properly in accordance with the official directives and regulations that apply in your area.

In the best interest of continued technological progress we reserve the right to change the design and configuration of any product without prior notice.

For that reason, no claims can be accepted with reference to text and illustrations in this manual.

Symbols

The following symbols are used in this instruction manual and on the device itself:

In the instruction manual:



Read the manual carefully.



DANGER! Failure to comply with the instructions could cause accidents with potentially life-threatening injuries.



Wear the prescribed protective clothing.



Wear protective gloves.



Wear face protection (e.g., safety goggles).



Wear breathing mask.



Smoking prohibited.



No naked flames.



Minimum distance to bystanders: 15 m (approx. 16 yards)

On the device:

Pump toggle switch (12):

- Pump switched on for low operating pressure (setting I), with standard nozzle: approx. 2.46 bar [35.7 psi]
- Pump switched off (setting "O")
- = Pump switched on for high operating pressure (setting II), with standard nozzle: approx. 4.3 bar [62.4 psi]

 Electrical equipment must not be disposed of as normal domestic waste. Ensure that the device and all electrical accessories are disposed of or recycled at an official disposal or recycling facility for electrical equipment.

National requirements

The pressure sprayer may be subject to national requirements for regular inspection by designated bodies, as provided for in Directive 2009/128/EC¹.

¹ Directive 2009/128/EC of the European Parliament and of the Council of 21 October 2009 establishing a framework for Community action to achieve the sustainable use of pesticides

Table of contents

1 Warranty	4
2 Wearing parts	4
3 Safety regulations	4
3.1 <i>Correct use / areas of application</i>	4
3.2 <i>General safety instructions</i>	5
3.3 <i>Work clothing / personal protection equipment (PPE)</i>	5
3.4 <i>Safe handling of spraying agents</i>	6
3.5 <i>Safe handling of the rechargeable battery and the charger</i>	6
3.6 <i>Transportation of the device</i>	7
3.7 <i>Before and during work</i>	7
3.8 <i>Maintenance, repairs and storage</i>	7
4 Type plate	8
5 Operating and functional components	8
6 Preparing the device for use	10
6.1 <i>Assembly</i>	10
6.2 <i>Spray nozzle, ball valve filter and filling strainer</i>	10
6.3 <i>Charging the battery</i>	11
6.4 <i>Adjusting the carrying straps</i>	11
6.5 <i>Trial run</i>	11
7 Mixing spraying agents and filling the spraying agent tank	12
8 Using the pressure sprayer	13
8.1 <i>Spraying</i>	13
8.2 <i>Residual spraying agents / finishing spraying</i>	14
9 Maintenance, cleaning and storage	14
9.1 <i>General operating and maintenance instructions</i>	14
9.2 <i>Trial run</i>	14
9.3 <i>Checking the spray nozzles and the ball valve filter by measuring the spraying agent delivery rate</i>	14
14	
9.4 <i>Changing the spray nozzle and the ball valve filter</i>	15
9.5 <i>Information on using the rechargeable battery</i>	15
9.6 <i>Replacing the fuse</i>	15
9.7 <i>Greasing the cap gasket</i>	15
9.8 <i>Draining the spraying agent tank and cleaning the spraying agent carrying parts</i>	15
9.9 <i>Taking the sprayer out of service and putting it into storage</i>	16
10 Maintenance plan	17
11 Standard delivery	17
12 Specification and special accessories	18
13 Specification of spray nozzles	19

1 Warranty

We warrant problem free quality and will cover the cost of replacing parts which are found to be faulty in material or show manufacturing defects within the prescribed guarantee period after the date of purchase.

Please note that specific guarantee conditions may differ from country to country.

When in doubt, please ask the vendor of the goods. The vendor of the product is responsible for guarantee applications.

We hope you will understand that we cannot be liable for damage resulting from these causes:

- Non-compliance with operating instructions.
- Neglecting required maintenance and repair jobs.
- Wear from normal use (particularly: gasket seals, membranes, collars, spray nozzles and filters).
- Using non-approved tools.
- Use of force, improper treatment, misuse and accidents.
- Attempted adjustments and repairs by non-qualified persons.
- Unauthorized modification or changes made to the device.
- Use of unsuitable spare parts or non-genuine parts if such parts are the cause of the damage.
- Use of non-approved media in the spraying agent tank.
- Damage caused by using the product in the hire or rental industry.

Normal cleaning, adjustments or maintenance jobs cannot be claimed as part of the guarantee.

All guarantee work must be carried out by one of our authorised service centres.

For Australia only: Supplementary warranty notes specifically for Australia

To make a claim, contact Clayton Engineering, 26 French Ave, Brendale, Q, 4500 on phone 1300 798 022 or email sales@claytonengineering.com.au. You will be asked to provide proof of purchase and then will be instructed on the procedure for repairing or replacement of the product under warranty. All costs incurred for repair or replace, and additional claims can be discussed at this stage.

This warranty is provided in addition to other rights and remedies you have under law: Our goods come with guarantees that cannot be excluded under the Australian Consumer Law. You are entitled to a replacement or refund for a major failure and for compensation for any other reasonably foreseeable loss or damage. You are also entitled to have the goods repaired or replaced if the goods fail to be of acceptable quality and the failure does not amount to a major failure.

2 Wearing parts

Various parts are subject to application-specific wear or to normal wear and must be replaced in good time if necessary.

The following parts are subject to normal wear and are not covered by the manufacturers guarantee:

- All rubber parts that come into contact with the spraying agent
- Spray nozzle
- Filters
- Seals
- Rechargeable battery
- Fuse

3 Safety regulations

3.1 Correct use / areas of application

- This pressure sprayer must only be used for the purpose of applying approved liquid plant protection agents, pesticides, insecticides, weed killer (herbicides) and liquid fertilizers available from authorised specialist dealers as well as for the purpose of applying clean water.
- Observe all instructions provided by the spraying agent manufacturer.
- We recommend using only spraying agents that have been approved for use as spraying agent for the above mentioned areas of application by the relevant authorities in your country.
- The pressure sprayer must only be used for applications in agriculture, tree nurseries, forestry, fruit and vegetable growing, vineyards, home and garden and greenhouse cultivation with adequate ventilation.
- The pressure sprayer must not be used for any other purposes, e.g., for the spraying of liquid paint or applying any other media than the above mentioned liquids!
Particularly, aggressive, acid- or solvent-containing liquids or impregnating agents must not be sprayed with this device!
- Never use fluids with a temperature in excess of 40 °C [104 °F].
- To enable the operator in connection with the spraying agent manufacturer to check the material resistance to certain chemicals, we will provide details of the type of materials used for the pressure sprayer.

3.2 General safety instructions



Please take the time to carefully read through these operating instructions before using the device for the first time and keep them in a safe place thereafter.

Always take great care when using the device.

You can put your life at risk by failing to follow the safety instructions.

It is also important to follow any relevant health and safety regulations that apply to your place of work.

Anyone who fails to follow the safety instructions, operating instructions or maintenance instructions will make themselves liable for any damage and consequential damage caused as a result.

The operating instructions must be kept available at all times wherever the device is used or stored. They must be read by anyone instructed to use the equipment or perform work with or on the device (including servicing, maintenance and repairs).

- A first time operator should obtain practical instruction by an authorised SOLO dealer before using the equipment.
- Persons under the age of 18 are only permitted to use this plant protection device under supervision.
- Keep persons and animals away from areas in which you are working. Never spray in the direction of other persons, animals or objects that could be damaged as a result. Bear in mind that the liquid emerges at high speed from the spray nozzle. Objects could be kicked up as a result, and this could in some cases represent a risk. The user is responsible for any hazards or accidents involving other persons and/or their property.
- This equipment must only be hired out, lent or passed on to persons who are familiar with this type of equipment and its operation and who have read the operating instructions. Always ensure that you hand over the operating instructions together with the device.
- Ensure that you are in good shape, well rested and healthy when using this device. Do not use this device, if you are tired or sick.
- Never use this device under the influence of alcohol, drugs or medication that could impair your reaction speed.
- Never alter, change or modify any safety equipment or operating controls.
- Never use the device if any part of it is unsafe or if it is not in an overall condition that makes it safe to use. Before using the device always check whether it is safe to use according to section 10.
- Immediately replace damaged parts. Only use genuine SOLO replacement parts.

- Only use accessories and add-on parts that have been supplied and specifically approved for installation on the device by us.
- The quality of any spare parts used is also an important factor in ensuring that your device is reliable and safe to use. Always use genuine SOLO replacement parts, as these are the only parts that have been manufactured with the same equipment and under the same conditions as the parts originally fitted to the device. This ensures the highest possible level of quality and accuracy of fit – vital factors in ensuring the safety, reliability and proper functioning of your device. Genuine SOLO replacement parts and accessories are available from your authorised SOLO dealer. He also has access to the necessary spare parts lists, from which the required part numbers can be taken, and he will also be kept up to date about any minor improvements and changes to the range of parts on offer. Please note that the use of non-genuine replacement parts will invalidate your warranty.
- When the device is not being used it should be safely stored in a place where it will not endanger the health and safety of others. Prepare the device for storage according to section 9.8. Ensure that the device is stored in a safe place where unauthorised persons cannot access it.

3.3 Work clothing / personal protection equipment (PPE)



Always wear suitable protective clothing in accordance with the relevant regulations.

The clothing must protect all parts of your body against contact with spraying agents and against objects that are kicked up – i.e., protective gloves, face protection (e.g., protective goggles), protective footwear, body protection (e.g., rubber apron), if required breathing protection.

- Clothing should be appropriate – i.e., tight-fitting, but not obstructive.
- Wear protective shoes with good grip, preferably safety shoes.
- Wear protective gloves with non-slip palms.
- Wear face protection (e.g., safety goggles) against the spraying agents.
- Always wear a breathing mask when working in dense and tall plants, in greenhouses, in dips in the ground or in trenches and when using dangerous spraying agents.
- Immediately change any clothing that becomes soaked with the spraying agent.
- Wash the work clothing regularly.
- Never wear a scarf, tie, loose jewellery or other items of clothing that could be caught in a bush or on a branch.

3.4 Safe handling of spraying agents

- Avoid contaminating the environment, the mains water supply and/or public sewer systems with spraying agent or cleaner!
Ensure to avoid contamination when mixing, filling, using, draining, cleaning, servicing and transporting by using adequate procedures and suitable containers.
- Spraying agents and cleaners must never be allowed to enter the mains water supply – not even by back-suction when filling, public sewer systems, sprayed onto wastelands, allowed to drain into natural bodies of water or disposed of together with normal domestic waste. This also means that appropriate care must be taken during filling to ensure that none of the spraying agent is drawn back into water pipes. Spraying agents and cleaners and any unused leftovers of spraying agents and cleaners must always be collected in a suitable container and disposed of via approved facilities for household chemical waste. Please contact your local authorities for information about your nearest disposal facilities.
- Avoid any direct contact with spraying agents. In case of contact with health hazardous spraying agents, immediately rinse the affected body parts with plenty of clean water, immediately change the clothing soaked with spraying agents and immediately seek medical advice.
- Never eat or drink when handling spraying agents.
- Stop working immediately if you start to feel unwell while working, or if you become unusually tired. Seek medical advice if the condition persists.
- Never allow children or anybody who is not familiar with handling this type of spraying agent to handle the spraying agent.
- Clean the spraying agent tank and all other spraying agent carrying parts whenever the spraying agent is changed. To flush out any residue from the pump and the hose, run the pressure sprayer with clean water after cleaning the spraying agent tank and before the next spraying agent is filled in. This will prevent the risk of any chemical reactions taking place between the different substances.
- Never spray in narrow or enclosed spaces – spraying agents are toxic and there is a risk of poisoning. Spraying equipment must for example only be used in greenhouses if adequate ventilation is provided. Signs must be put up in greenhouses that have been treated. Nobody should enter the greenhouse again until it has been thoroughly ventilated.
- When you have finished spraying, prepare the device for storage according to section 9.8, thoroughly wash your face and hands with soap,

take off your work clothing and ensure that it is washed regularly.

Any unused spraying agent that is left over in the device could cause corrosion and hence damage the device. Special attention must be paid to wearing parts like spray nozzles, filters and seals.

3.5 Safe handling of the rechargeable battery and the charger

- Only use the charger to charge the battery. For this purpose only, connect the charger to a mains supply with an operating voltage between 100V and 240V AC 50/60Hz. It must only be connected using the correct adapter plugs.
 - Check that the mains voltage is correct before connecting the device.
 - Use the correct mains adapter plug.
 - The charger must not be connected to the mains supply in countries for which no matching mains adapter plug is supplied together with the backpack sprayer or in countries where the mains voltage differs from the operating voltage of the charger. In this case you should contact a local dealer to enquire about options for connecting the charger to the mains supply.
 - Do not carry out the charging unattended.
 - After charging (at the latest after 8 hours) disconnect the charger from the power supply immediately.
- Always hold the charger itself to push it into the electrical socket or to pull it out. Never pull on the cable.
- The charger is only designed to recharge the rechargeable battery that is supplied by SOLO for this pressure sprayer. Ensure that the battery is always correctly connected to the charger before charging.
- Always switch off the pump when the charger is connected.
- Never connect the two terminals of the rechargeable battery (+ / -) with a conducting object (short circuit).
- Keep the charger, the rechargeable battery and all of the electronics well away from splash water. These areas should only be cleaned with a dry or slightly damp cloth. Before cleaning, always disconnect the power plug from the socket and the charging cable from the charging socket on the device.
- The rechargeable battery contains dangerous substances. Never open the battery or the charger.
- Only use the genuine charger to recharge the battery.

- The rechargeable battery and the charger must not be disposed of as normal domestic waste. Ensure that you take them to an official disposal facility for electrical equipment.

3.6 Transportation of the device

- Always switch off the pump when transporting the device.
- To prevent damage and to eliminate potential hazards for other road users, use secure lashing equipment to secure the device and prevent it from tipping over and falling when transporting it on a vehicle.
- Take appropriate measures to ensure that the spraying agent cannot leak or spill. Check the spraying agent tank, the pump and all hoses and pipes that carry the spraying agent for leaks. Before transporting the device you should ideally prepare the device for transportation according to section 9.8.

3.7 Before and during work

- Every time before you start using the device, check the entire device to ensure it is safe to use according to section 10.
- Check the spraying agent tank, the pump and all hoses and pipes that carry the spraying agent for leaks.
- Never start working if there are any irregularities or leaks, if you can see any damage to the equipment (including the support frame), if any of the adjustment settings are incorrect or if the equipment is not working properly in any way. In this event have the device checked by an authorised SOLO workshop.
- In case of serious disturbances or accidents during operation of the device as smoke, strong odors from the device or if the device is in flames instantly remove the unit from your body and take a safe distance. In case of fire, you have to call the fire department immediately.



- The device must only be operated by one person at a time. Nobody else must be within a radius of 15 metres [approx. 16 yards] at the same time.
- When switching on the pump, ensure that the shut-off valve is closed. Point the spray tube towards a free area.
- Always ensure that there is an adequate air change when working in restricted conditions, in tight, tall plant growth, in greenhouses, in dips in the ground or in trenches.
- Always remain within calling distance of other persons who could help in the event of an emergency.
- Take breaks at regular intervals.
- Never eat or drink when using spraying agents.



- Never smoke in areas where you are working.
- When removing the spray tube, do not point to yourself or other persons with the end of the tube.

3.8 Maintenance, repairs and storage

Only perform maintenance work and repairs by yourself if they are covered in these operating instructions. All other work must be carried out by an authorised SOLO workshop.

The repair of modern devices and their safety-relevant assemblies, requires qualified, specialized training and a workshop equipped with special tools and test devices. The specialist has the required training, experience, and equipment at his disposal to provide you with the most cost-effective solution and can help you in many ways with advice and service.



- The device must not be serviced, repaired or kept in the vicinity of naked flames.
- Before doing any maintenance work or repairs and before opening the spraying agent tank, switch off the pump and unplug the charger from the charging socket of the device.
- Always switch off the pump and depressurise the device before unscrewing the high-pressure hose (7), the shut-off valve (8), the pressure gauge (9, depending on the model), the spray tube (10) and the nozzle attachment (11). To depressurise the device, with the pump switched off, hold the spray tube in the spraying agent tank or in a suitable container for the spraying agent and operate the shut-off valve until no more fluid is sprayed.
- All repairs must only be performed using SOLO genuine replacement parts.
- The device must not be altered in any way, as this could adversely affect the safety of the device and potentially cause an accident or injury.

4 Type plate



- a: Name and address of the manufacturer
 b: Product designation
 c: Type designation "Typ"
 d: Serial number "SN"
 e: Weight (ready for operation, tank empty) "m_{net.}"
 f: Max. fill volume of the tank "V_N tank"
 g: Year of production
 h: Model number

5 Operating and functional components

View: left hand side

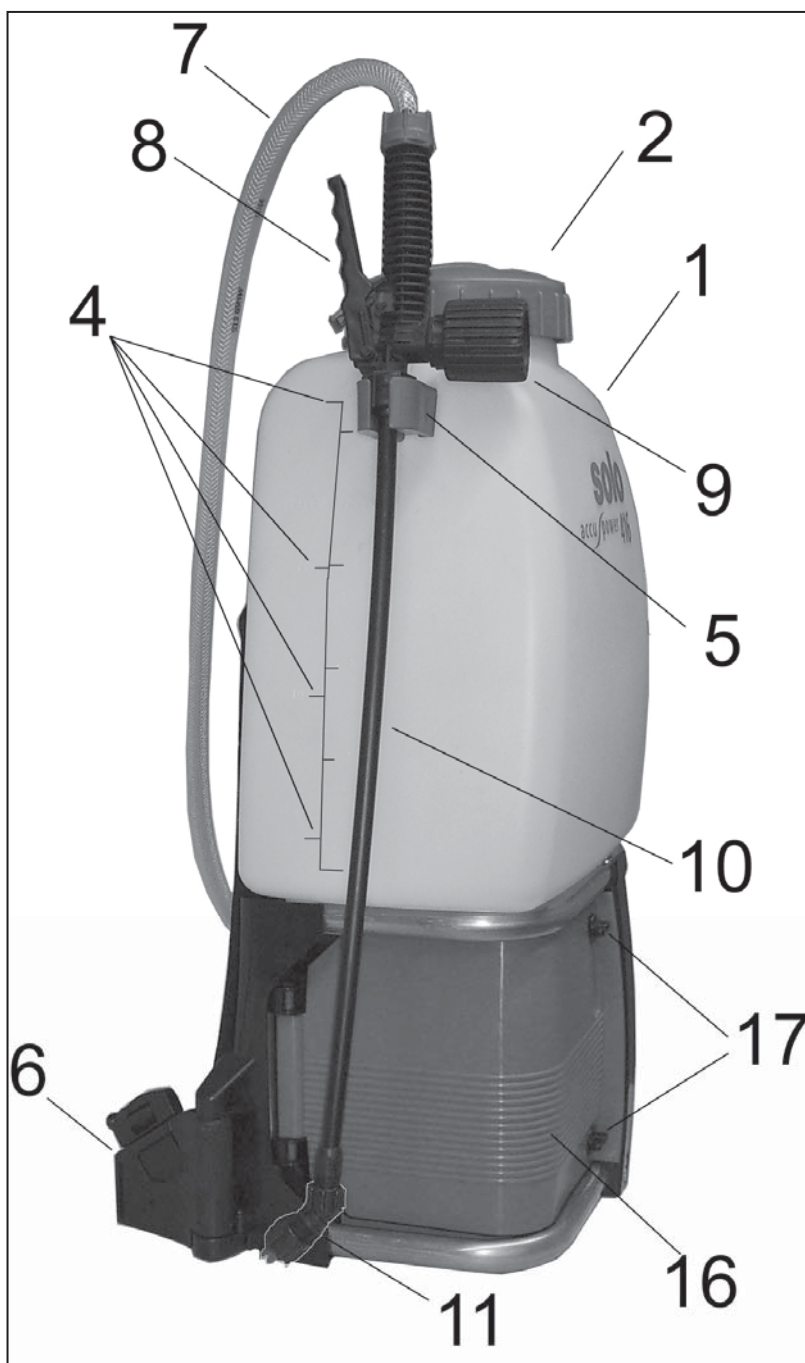

1. Spraying agent tank
2. Spraying agent tank cap
3. Filling strainer
4. Fill level markings
5. Spray tube holder
6. Strap holder with clip (carrying straps)
7. High-pressure hose
8. Shut-off valve
9. Pressure gauge (depending on the version)
10. Spray tube
11. Nozzle attachment
12. Pump toggle switch
13. Charging socket
14. Fuse holder
15. Type plate
16. Protective casing
17. Locking buttons
18. Drain valve
19. Drain hose (attached to the rear panel)
20. Rechargeable battery
21. Charger
22. Mains plug adapter
23. Velcro strap for fixing the rechargeable battery

View: top, spraying agent tank opened

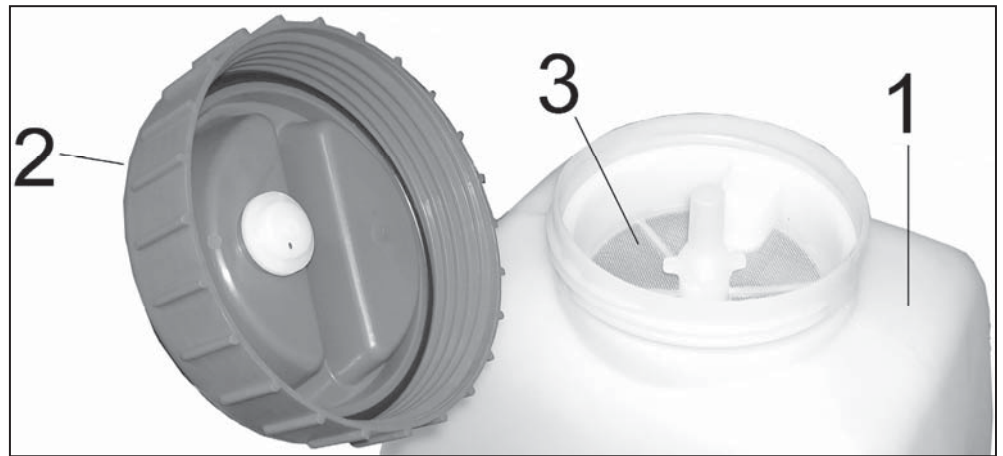

View: right hand side, lower part



View: protective casing opened

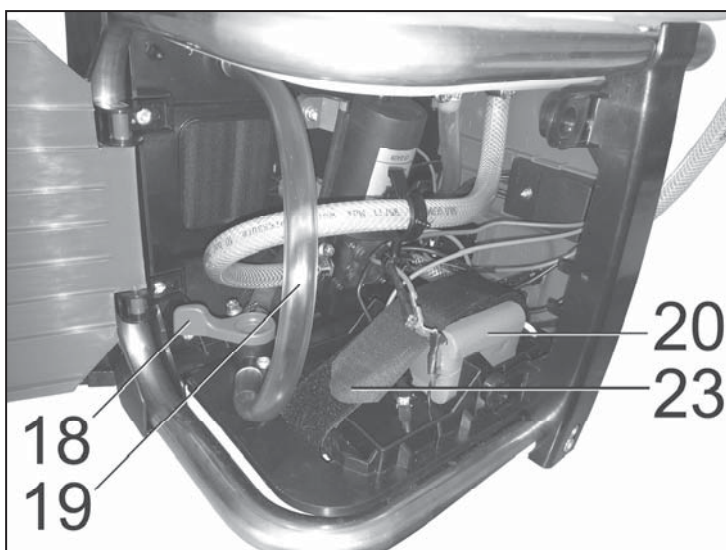

Charger and mains outlet adapter

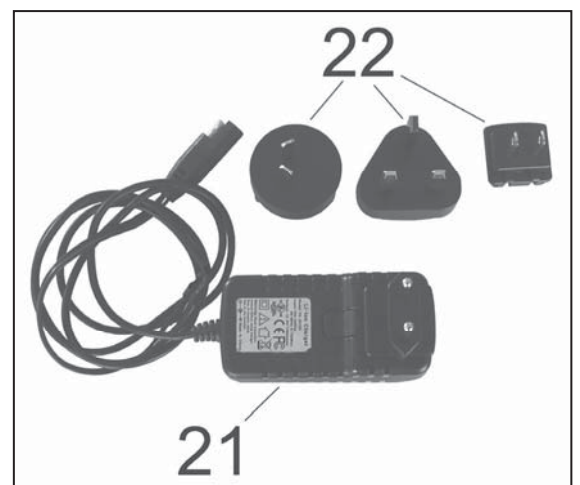

6 Preparing the device for use

6.1 Assembly

The pressure sprayer with rechargeable battery is dismantled before it is dispatched. It must be fully reassembled again before it is used.

Connecting the rechargeable battery:

Ensure that the pump toggle switch (12) is set to "O" (pump is switched off).



To open the protective casing, rotate both locking buttons (17) approximately 100° anti-clockwise. Open the protective casing.



Positive terminal: Pull down the safety cap from the positive pole connection of the battery and plug the plug of the positive cable firmly onto the battery connection.

Negative terminal: This connection is already installed in the factory state.

Check that the plugs are securely connected and that polarity is correct.

Close the protective casing and twist the locking buttons back in a clockwise direction until they are horizontal.

Assembly of the spray tube (10):

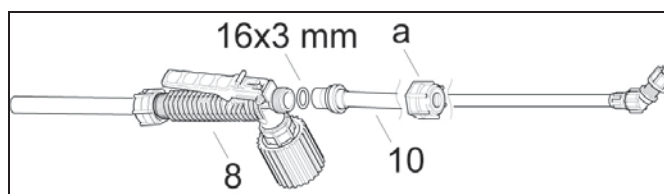

- The O-ring (16x3 mm) is used to provide a seal between the spray tube (10) and the shut-off valve (8). Manually tighten the union nut (a) on the shut-off valve.

When your work is completed, the spray tube should be fitted in the spray tube holder.

Installation of the pressure gauge (depending on the model):

- Unscrew the black threaded collar from the shut-off valve.
- Screw the black threaded collar of the pressure gauge accessory kit onto the shut-off valve.
- Insert the O-ring into the threaded collar and screw the pressure gauge hand-tight into the threaded collar. Do not use any tools!

6.2 Spray nozzle, ball valve filter and filling strainer

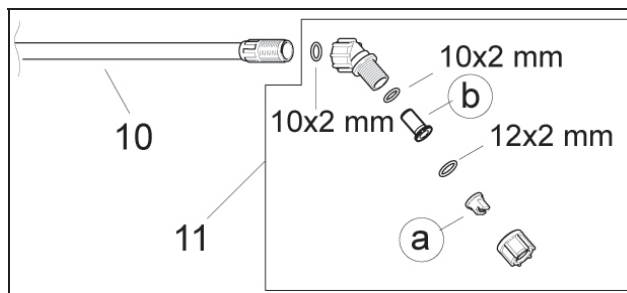

Firmly screw the nozzle attachment (11) with the O-Ring (10x2 mm) hand-tight onto the spray tube. Do not use any tools!

At the factory, a flat jet nozzle 03-F80 blue (a) is assembled as the standard nozzle.

Delivery rate: See section 13

A ball valve filter (b, part no.: 49539, mesh aperture: 0.35 mm [0.0138"]) is fitted in the elbow piece upstream of the spray nozzle. The filter minimises any dripping from the nozzle when the shut-off valve is closed.

The pressure sprayer is equipped with a filling strainer (3, mesh aperture: 0.7 mm [0.0276"], part no.: 13267] located in the filler neck of the spraying agent tank.

Only the spray nozzles listed in section 13, the above mentioned genuine ball valve filter and the above mentioned genuine filling strainer must be used in this pressure sprayer.

Changing spray nozzles and ball valve filter:
See section 9.4

6.3 Charging the battery



Always switch off the pump when the charger is connected.

The rechargeable battery needs to be charged before you can use the pressure sprayer for the first time.

Charging time: At least 5 ½ hours

Before charging, connect the battery as described in section 6.1.

Connect the charging cable of the charger to the charging socket (13) of the pressure sprayer.

Connect the adapter that suits the country specific electrical socket to the charger.

Connect the charger to a suitable mains supply system.

The charger automatically adapts to any AC 50/60 Hz mains voltage between 100 V and 240 V.

While the battery is charging, the LED on the charger lights up red. Once the battery is fully charged, the LED switches to green.

Once the charging process is finished, disconnect the power plug from the socket and then disconnect the charging cable from the charging socket on the pressure sprayer.

6.4 Adjusting the carrying straps

Clip the carrying straps into the clips (6) on both sides and lift the pressure across your shoulders.

Use the sliding clips to adjust the shoulder straps to the right length.

Pull the loose ends of the carrying straps to tighten them.

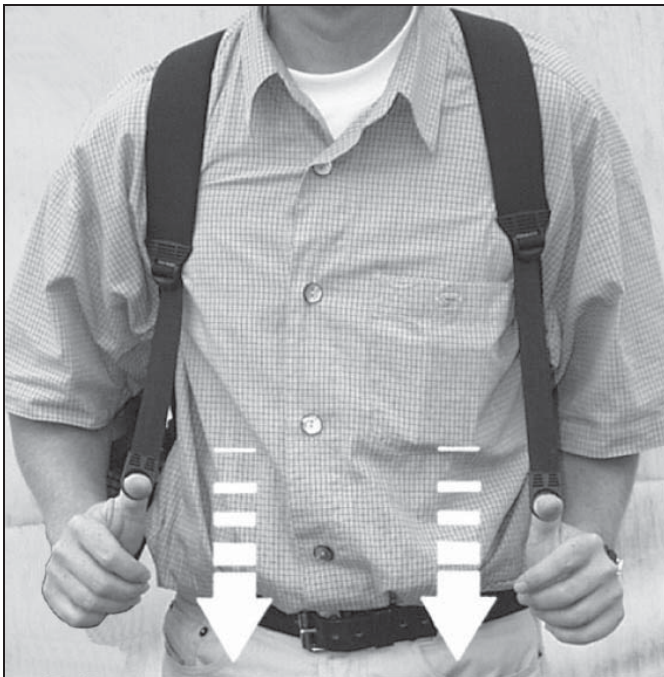

Lift up the two sliding clips again to release the straps.

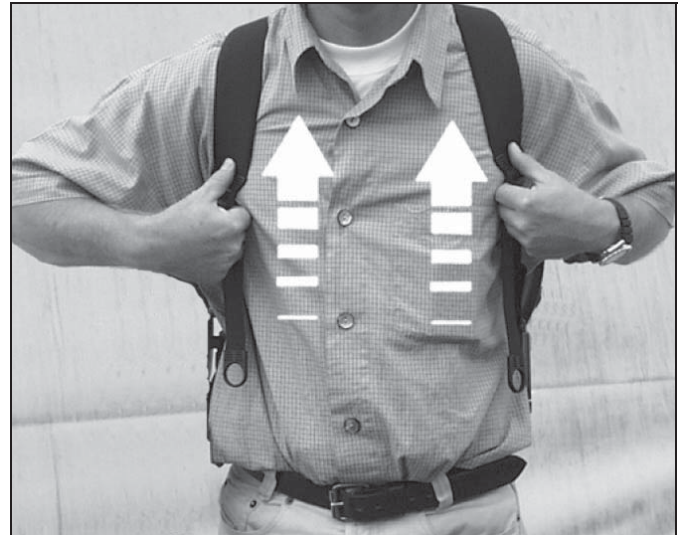

When adjusting the straps, ensure that the back panel fits snugly and securely against the back of the person wearing the pressure.





Fit the bottom strap around the midriff of the wearer and close the clip, again using the sliding clips to adjust the length of the straps as required.

6.5 Trial run

At the first start-up, at the start of the spraying season and in frequent use at least once a month, perform a trial run according to section 9.2 to check the entire device.

7 Mixing spraying agents and filling the spraying agent tank

 When handling the spraying agents, always follow the safety instructions of these operating instructions (pay special attention to section 3.4) and the information provided by the manufacturer of the particular spraying agent.

 Before opening the spraying agent tank, switch off the pump, unplug the charger from the charging socket of the device and depressurise the device! To depressurise the device, with the pump switched off, hold the spray tube in the spraying agent tank or in a suitable container for the spraying agent and operate the shut-off valve until no more fluid is sprayed.

Spraying agent volume:

Mix the spraying agents according to the instructions provided by the manufacturer of the spraying agent. Choose the appropriate volume according to requirements.

Mixing spraying agents:

Only mix spraying agents out in the open. Never do this inside living spaces, stables or in storage spaces that are used for food or animal feed. Never mix the spraying agent directly in the spraying agent tank.

Spraying agents in powder form:

- Mix the spraying agent in a separate container, not in the spraying agent tank.
- Ensure that the mixture is thoroughly mixed before pouring it through the filling strainer into the spraying agent tank.
- Use the spray tube to thoroughly mix the spraying agent in the tank.

Liquid spraying agents:

- Fill 1/4 of the spraying agent tank with clean water.
- Then pre-mix the spraying agent with clean water in a separate container according to the instructions provided by the manufacturer of the spraying agent.
- Pour the pre-mixed spraying agent through the filling strainer into the spraying agent tank.
- Top up with the required amount of clean water according to the manufacturer's instructions.
- Use the spray tube to thoroughly mix the spraying agent in the tank.

When using spraying agents that have been mixed from herbal preparations, the liquid needs to be pre-filtered before pouring it through the filling strainer, as otherwise the strainer may become blocked.

Filling the spraying agent tank:

 Always ensure that the pump is switched off (setting "O" of the pump toggle switch) and that the shut-off valve (8) as well as the drain valve (18) is closed (the lever should be set at right angles to the hose) before filling any fluids into the spraying agent tank. Take the device off your back and place it on a suitable surface on the ground.

When filling the spraying agent tank, always use the filling strainer located in the filler neck of the spraying agent tank and observe the total filling process.

Before filling the tank check the filling strainer for dirt or damages.

Cleaning the filling strainer: See section 9.8

If the strainer is damaged, replace it by a genuine SOLO replacement part (part no.: 13267, mesh aperture: 0.7 mm [0.0276"]).

Avoid any direct contact of the filling hose and the contents of the spraying agent tank.

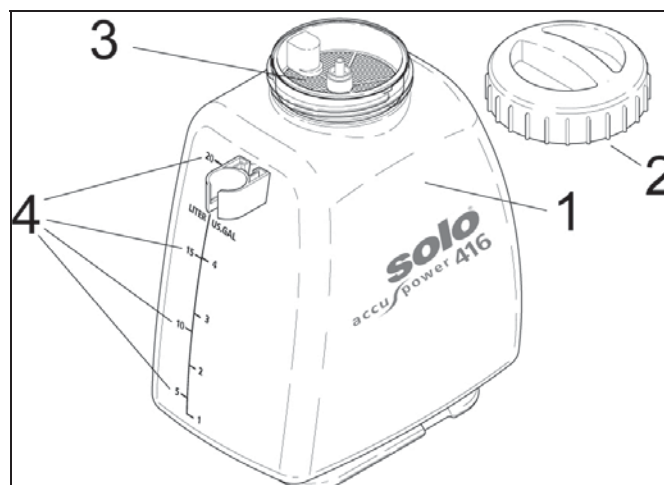

Fill level markings (4) are applied to the side of the spraying agent tank (1).

The spraying agent tank has a maximum capacity of 20 litres [5.28 gal] (top marking). When filling up the spraying agent tank, ensure you do not fill above the top marking.

Never allow the spraying agent tank to overflow or public bodies of water, rainwater drains or sewage drains to become contaminated.

Immediately wipe up any spilled spraying agent.

After filling, firmly close the spraying agent tank cap (2) on the filling opening to prevent the spraying agent from escaping.

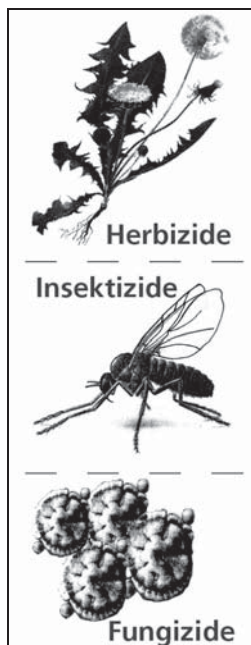

Identification of the tank contents:

Attach the relevant sticker to the spraying agent tank to indicate the contents of the tank (i.e., herbicide, fungicide or insecticide).

The designation of the spraying agent used has to be attached to the device and has to be updated every time when the spraying agent is changed.



CAUTION:

Never fill different spraying agents into the spraying agent tank without first thoroughly cleaning the tank and all parts that come into contact with the spraying agent and flushing the system with plenty of clean water.

Never use aggressive, acid- or solvent-containing cleaning agents (gasoline for example).

8 Using the pressure sprayer



Ensure that you follow all of the safety instructions when using the pressure sprayer.

Every time you use the pressure sprayer, first check it all over to ensure it is safe to use according to section 10.

8.1 Spraying

- When applying spraying agent, ensure by using appropriate measures and procedures that the unintended release of agent to other areas is minimized and the drift to the surrounding areas is prevented.
- Always proceed with the greatest care when spraying.
- Never use the device under windy conditions or if it is raining, as this would risk widespread drifting of the spraying agent.
- Check the wind direction before starting work and select the spraying direction downwind of the user.
- It is best to perform spraying work in the morning or evening, as it tends to be less windy then.
- Ensure that you only wet what is in fact intended to be covered with spraying agents.
- Never spray the agent towards persons, animals, open windows or doors, cars or

anything else that could be damaged by the spraying agent.

- Use the spray nozzle suitable for your application. Applicable nozzles: See section 13
- When spraying, ensure that the spraying agent is applied evenly and homogeneously to the treated area.
- Carry the properly adjusted and prepared device on your back.
- Leave the shut-off valve closed when you switch on the pump (i.e. do not pull the lever).
- Select the required operating pressure at the pump toggle switch according to the required range and delivery rate.
In setting II the pump automatically switches off when the operating pressure is reached at the shut-off valve. If the pressure drops while spraying, the pump will automatically switch back on again. This ensures that the full capacity of the rechargeable battery is used in the best possible way.
In setting I, the switch-off pressure may not always be attained even if the shut-off valve is closed, and the pump will then run continuously as a result. In this case we recommend switching the pump off manually using the toggle switch during breaks in spraying.
Always completely switch off the pump using the toggle switch before extended breaks or at the end of spraying.
- Never allow the pump to run with an empty spraying agent tank. Running the pump dry will result in pump damage.

Spraying:

Hold the spray tube at the shut-off valve in your hand.

Start the spraying process by pressing the shut-off valve (8).

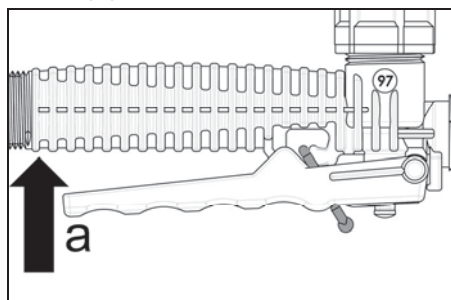

Releasing the shut-off valve stops the spray process.

The red clip can be used to secure the shut-off valve in its rest position to prevent accidental spraying. For this, pull the lever slightly away (a) from the handle and lock the clip (b).

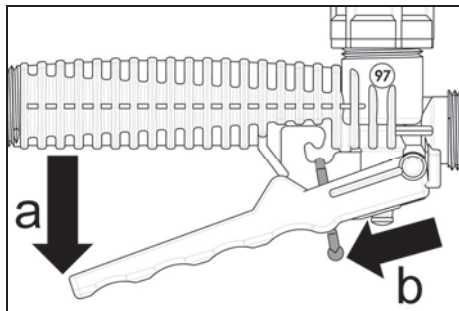

The spray tube (10) can be rotated in the shut-off valve (8) – after loosening the threaded collar. This is useful for spraying under leaves.

If the spraying agent is not applied properly, spray nozzle or ball valve filter could be blocked or damaged. If necessary, clean or replace the nozzle and the ball valve filter.

Cleaning: See section 9.8

Replacing the spray nozzle and the ball valve filter: See section 9.4

If the operating pressure built by the pump drops noticeably and the pump fails to get the pressure back up to the normal operating level, stop spraying with the current battery and recharge the battery.

8.2 Residual spraying agents / finishing spraying

Switch off the pump immediately when any air is sucked in and sprayed out through the spray nozzle. This is indicated by a mist being sprayed from the nozzle. At this point the spraying agent tank will still contain a residual amount of less than 250 ml [8.45 oz]. If you do not want to add more spraying agent and wish to stop spraying instead, dilute this leftover amount with 2.5 litres [0.66 gal] of clean water and spray it on the treated area. After switching off the pump, hold the spray tube facing down towards the treated area and operate the shut-off valve to discharge any residual quantities of spraying agent left in the high-pressure hose.

Never allow the pump to run with an empty spraying agent tank. Running the pump dry will result in pump damage.

When you finish working, prepare the device for storage according to section 9.8, thoroughly wash your face and hands with soap, take off your work clothing and ensure that it is washed regularly.

9 Maintenance, cleaning and storage

9.1 General operating and maintenance instructions

After running in the device for approximately 5 operating hours, check all accessible nuts, screws and bolts to ensure that they have not become loose. Retighten them as required.

9.2 Trial run

At least at the start of every spraying season and in frequent use at least once a month, perform a trial run with clean water to check the following:

- Tightness of all equipment components at maximum permissible pressure with open and closed shut-off valve
- Function of all active components (shut-off valve (8), pump toggle switch (12), pressure gauge (9, depending on the model))
- Dosing and distribution accuracy of all the nozzles used by measuring the spraying agent delivery rate according to section 9.3

Never start working if there are any irregularities or leaks, if you can see any damage to the equipment (including the support frame), if any of the adjustment settings are incorrect or if the equipment is not working properly in any way. In this event have the device checked by an authorised SOLO workshop.

9.3 Checking the spray nozzles and the ball valve filter by measuring the spraying agent delivery rate

Fill up the tank with clean water to the maximum marking, start it up and spray for exactly one minute. Then measure the quantity of water required to refill the tank to its maximum level. The value measured corresponds to the delivery rate of the device in l/min for the selected setting of the pump toggle switch.

This value must not deviate by more than 10 % from the value indicated in section 13.

If the actual value is too low, this may be caused by deposits in the spray nozzle and/or in the ball valve filter or a discharged battery.

Charge the battery, clean the parts and repeat the check.

If the actual value is too high, this may be due to wear or damage to the spray nozzle.

When checking the nozzles, also check whether the spray nozzle is producing an even, fan-shaped spray pattern.

If the delivery rate is still too low after cleaning the nozzle and the ball valve filter, or if the nozzle and/or the ball valve filter are worn or damaged, replace the nozzle and/or the ball valve filter by genuine SOLO replacement parts.

Changing the spray nozzle and the ball valve filter: See section 9.4

9.4 Changing the spray nozzle and the ball valve filter

Only the spray nozzles listed in section 13 and the genuine ball valve filter (part no.: 49539, mesh aperture: 0.35 mm [0.0138"]) must be used in this pressure sprayer.

 Before disassembling the nozzle attachment, switch off the pump, unplug the charger from the charging socket of the device and depressurise the device! To depressurise the device, with the pump switched off, hold the spray tube in the spraying agent tank or in a suitable container for the spraying agent and operate the shut-off valve until no more fluid is sprayed.

Changing the spray nozzle or the ball valve filter:

- Rinse the nozzle attachment with clean water.
- Disassemble the nozzle attachment (11).

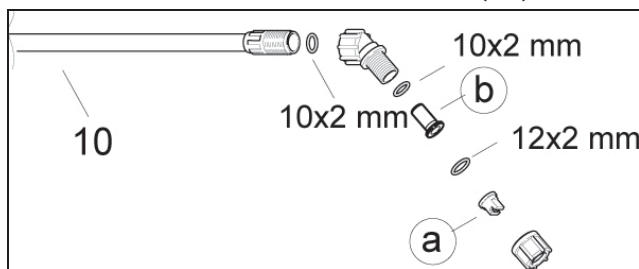

- Clean the O-rings, the ball valve filter (b) and the spray nozzle (a) with clean water and a soft brush. Never use your mouth to blow through the spray nozzle! Never use hard objects to clean the nozzles!
- Replace the previous nozzle by the new one or the previous ball valve filter by the new one.
- Reassemble the components of the nozzle attachment according to the above figure.

9.5 Information on using the rechargeable battery

When used properly, the rechargeable battery will remain in good working order for many years. It is important to note that the rechargeable battery should never be fully discharged.

If the operating pressure built by the pump while spraying drops noticeably and the pump fails to get the pressure back up to the normal operating level, stop spraying with the current battery and recharge the battery.

If the pressure sprayer with rechargeable battery is not used for an extended period of time, we recommend recharging the battery once a month with the supplied charger. This will prevent the battery from deep-discharging.

9.6 Replacing the fuse

The replacement glass fuse 5x20 mm 4A (part no.: 11358) can be ordered at your local SOLO dealer.

Replacing the fuse:

- Release the fuse holder (14) with a screwdriver (turn it half a turn anti-clockwise) and then pull it out.
- After inserting a new fuse, slide the fuse holder back in and lock it by twisting it half a turn clockwise.

If the fuse blows repeatedly, have the device checked by a specialist SOLO workshop before returning it into use.

9.7 Greasing the cap gasket

For proper sealing of the spraying agent tank, the cap gasket must be well greased with silicone grease.

9.8 Draining the spraying agent tank and cleaning the spraying agent carrying parts

 Before opening the spraying agent tank and before disassembling the nozzle attachment, switch off the pump and depressurise the device! To depressurise the device, with the pump switched off, hold the spray tube in the spraying agent tank or in a suitable container for the spraying agent and operate the shut-off valve until no more fluid is sprayed.

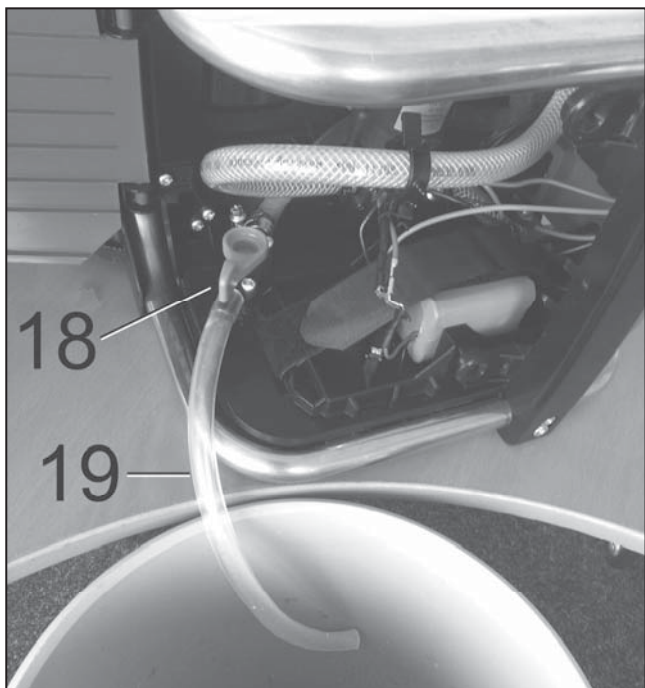
Draining the spraying agent tank:

- Place the pressure sprayer level on a horizontal surface.
- Rotate the two locking buttons (17) approximately 100° anti-clockwise to release the protective casing. Open the protective casing.
- Hold the end of the discharge hose (19) into a suitable container.
- Open the drain valve (18) (the lever should be set parallel to the hose).
- After draining: Close the drain valve (the lever should be set at right angles to the hose) and reattach the discharge hose to the rear panel.
- Close the protective casing and twist the locking buttons back in a clockwise direction until they are horizontal.

Cleaning the spraying agent tank:

Drain the spraying agent tank and all other spraying agent carrying parts daily after use and particularly at the end of the spraying season and thoroughly flush them with clean water.

Any unused spraying agent that is left over in the device could cause corrosion and hence damage the device. Special attention must be paid to wearing parts like spray nozzles, filters and seals.

Please read and observe the cleaning instructions supplied with the spraying agent.

Never use aggressive, acid- or solvent-containing cleaning agents (gasoline for example).

After cleaning, leave the spraying agent tank open to dry.

Cleaning the filling strainer, the spray nozzle and the ball valve filter:

- Rinse the nozzle attachment with clean water.
- Disassemble the nozzle attachment (11).
- Clean the filling strainer, the O-rings, the ball valve filter and the spray nozzle with clean water and a soft brush. Never use your mouth to blow through the spray nozzle! Never use hard objects to clean the nozzles!
- Reassemble the components of the nozzle attachment.

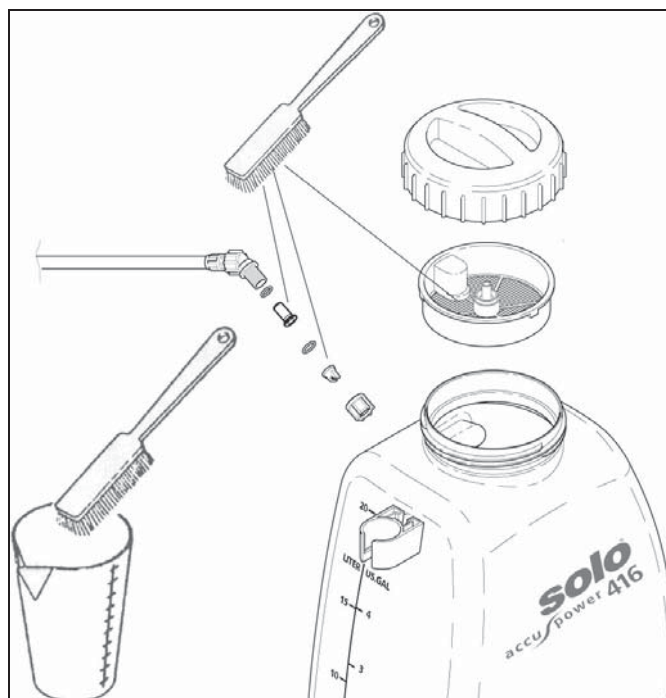
**9.9 Taking the sprayer out of service and putting it into storage**

Prepare the device for storage according to section 9.8.

Store the device protected from sunlight in a secure, dry and frost-free location at a maximum ambient temperature of 35 °C [95 °F].



There must not be any open fires or similar nearby.

Even when the device is not in use, regularly recharge the battery (and the spare battery if you have one) once a month with the supplied charger.

Ensure that the unit cannot be used by unauthorised persons, in particular children.

10 Maintenance plan

		Before you start working	After work	When changing the spraying agent	On demand	Monthly	Annually or at the start of the season
Entire pressure sprayer	Check whether the device is safe to use: <ul style="list-style-type: none"> • Visual inspection of the device • Check the tightness of all equipment components (at maximum permissible pressure with open and closed shut-off valve) • Check the function of all active components (shut-off valve, pump toggle switch, pressure gauge (depending on the model)) 	X					
Hoses and their screw connectors	Visual inspection	X					
Spraying agent tank	Visual inspection	X					
	Clean (section 9.8)		X	X			
Nozzles and ball valve filter	Clean (section 9.8)		X	X	X		
	Trial run to check the spray nozzles and the ball valve filter by measuring the delivery rate (section 9.3) X*: A monthly trial run is required only if the device is used frequently.				X	X*	X
Filling strainer	Visual inspection	X					
	Clean (section 9.8)		X	X	X		
Cap gasket	Grease (section 9.7)				X		X
Rechargeable battery (and the spare battery if you have one)	Recharge (section 6.3)				X	X	

Never start working if there are any irregularities or leaks, if you can see any damage to the equipment (including the support frame), if any of the adjustment settings are incorrect or if the equipment is not working properly in any way. In this event have the device checked by an authorised SOLO workshop.

If you have any questions please refer to your authorised SOLO dealer.

11 Standard delivery



- Standard device with shut-off valve assembled on the high-pressure hose
- Spray tube
- Nozzle attachment including O-ring (10x2 mm)
- Charger with EURO plug and 3 mains plug adapters for different countries
- Sticker for the spraying agent tank: herbicide, fungicide and insecticide
- These operating instructions, the EC declaration of conformity on a separate piece of paper

12 Specification and special accessories

Spraying agent tank	Max. fill volume Tank volume	20 l [5.28 gal] 22 l [5.81 gal]
Filling strainer	Mesh aperture Part no.	0.7 mm [0.0276"] 13267
Residual volume not properly discharged by the device		< 250 ml [8.45 oz]
Permissible operating temperature		0–40 °C [32–104 °F]
Operating pressure with standard nozzle	Setting I Setting II	Approx. 2.46 bar [35.7 psi] Approx. 4.30 bar [62.4 psi]
Max. delivery with standard nozzle	Setting I Setting II	1.07 l/min [0.282 USgal/min] 1.42 l/min [0.375 USgal/min]
Pressure hose	Length	1,500 mm [59"]
Standard spray nozzle (blue flat spray tip 03-F80)	Part no.	13160
Accessories: Nozzle kit with 9 different nozzles	Part no.	49574
Ball valve filter	Mesh aperture Part no.	0.35 mm [0.0138"] 49539
Pump		Electric pump 12 V
Rechargeable battery (Li-Ion)	Rated voltage Capacity	11.1 V 7.8 Ah
Battery charger	Input operating voltage Frequency of operating voltage Rated output voltage Max. charging current Protection type / protection class	100–240 V AC 50/60 Hz DC 12.6 V 1.5 A IP 20 / II
Charging time with minimum initial battery charge		Approx. 5 ½ h
Possible operating time with standard nozzle per charging cycle setting I / setting II		Approx. 5.9 h / 3.7 h
Fuse (glass fuse, 5x20 mm, 4 A)	Part no.	11358
Weight	Ready for operation, spraying agent tank empty Ready for operation, spraying agent tank filled to max.	5.2 kg [11.5 lbs] 25.2 kg [55.6 lbs]
Dimensions without spray tube and pressure hose	Height Width Depth	670 mm [26.4"] 380 mm [15"] 250 mm [9.8"]
Sound pressure level ¹ L _{Peq} according to EN ISO 3744		< 70 dB(A)
Sound power level ¹ L _{Weq} according to EN ISO 3744		< 70 dB(A)
Weighted effective acceleration ¹ a _{hv,eq} according to EN ISO 5349		< 2.0 m/s ² [78.7 "/s ²]

¹ In determining the above mentioned values regarding the acceleration of vibrations and sound, the different operating conditions were weighted in accordance with the current standards.

13 Specification of spray nozzles

Specification	Part no.	Pump toggle switch	Delivery l/min [USgal/min]	Spraying pressure bar [psi]	Spraying angle	Applications
Hollow cone jet 1 mm [0.039"] orifice, grey ²	13203 + 13202	I II *	0.71 [0.19] - *	3.54 [51.3] - *	50–70°	For treatment of shrubs, bushes and trees
Hollow cone jet 1.4 mm [0.055"] orifice, black ²	13201 + 13202	I II	1.03 [0.27] 1.37 [0.36]	2.58 [37.4] 4.52 [65.6]	50–70°	
Hollow cone jet 1.8 mm [0.071"] orifice, blue ²	13198 + 13202	I II	1.25 [0.33] 1.65 [0.44]	2.00 [29.0] 3.49 [50.6]	50–70°	
No-drift DT 1,0 yellow ²	13117	I II *	0.83 [0.22] - *	3.19 [46.3] - *	105°	
No-drift DT 2,5 brown ²	13164	I II	1.43 [0.38] 1.90 [0.50]	1.56 [22.6] 2.72 [39.5]	110°	
Adjustable spray nozzle ²	49206 (brass)	I II **	0.70–1.34 [0.18–0.35] 1.36–1.76 ** [0.36–0.46] **	3.60–1.80 [52.2–26.1] 4.5–3.1 ** [65.3–45.0] **		
	49525 (plastic)	I II *	0.70–0.96 [0.18–0.25] - *	3.60–2.80 [52.2–40.6] - *		
Flat spray tip 015-F80, green ²	13158	I II *	0.66 [0.17] - *	3.73 [54.1] - *	80°	Areal and row treatment 
Flat spray tip 02-F80, yellow ²	13156	I II *	0.82 [0.22] - *	3.20 [46.4] - *	80°	
Flat spray tip 03-F80, blue ¹	13160	I II	1.07 [0.28] 1.42 [0.38]	2.46 [35.7] 4.30 [62.4]	80°	
Flat spray tip 04-F110, red ²	13049	I II	1.27 [0.34] 1.68 [0.44]	1.94 [28.1] 3.40 [49.3]	110°	

¹ Standard equipment

² Accessories

* The setting II of the pump toggle switch is not allowed.

** Recommendation: Open the adjustable brass spray nozzles (part no.: 49206) entirely, if you want to work with the position II of the pump toggle switch.

solo[®]

Made in Germany



SOLO Kleinmotoren GmbH

Industriestraße 9

D-71069 Sindelfingen

Postfach / PO Box 60 01 52

D-71050 Sindelfingen

DEUTSCHLAND / GERMANY

Tel.: +49 (0)7031 301-0

Fax: +49 (0)7031 301-202

info@solo-germany.com

<http://solo.global/>